

Skjutlag	Tavla	Håkan Lidman		
1	3	Piteå Skf	Ligg	
04.07.2020	Tavelträffen gevär Ligg	Piteå Skytteförening		
5 prov		1: 10.1 → 2: 10.6x ↓ 3: 10.8x ↓	5 ligg 	1: 9.4 ↓ 2: 9.4 ↓ 3: 10.2 → 4: 9.7 ↑ 5: 10.5x →
	Serie 30 (2x) Total 0 (0x)		Serie 47 (1x) Total 47 (1x)	
5 ligg		1: 9.4 ↙ 2: 10.6x ↑ 3: 10.6x ↑ 4: 10.8x ← 5: 10.4 ↓	5 ligg 	1: 10.2 ↗ 2: 10.5x ↙ 3: 10.1 ↑ 4: 10.7x ↓ 5: 10.5x →
	Serie 49 (3x) Total 96 (4x)		Serie 50 (3x) Total 146 (7x)	
5 ligg		1: 10.1 ↓ 2: 9.8 → 3: 10.4x ← 4: 10.8x ↑ 5: 10.2 ↑	5 ligg 	1: 8.6 ↗ 2: 10.4 ↓ 3: 10.8x ↑ 4: 10.1 ↑ 5: 10.4x ↗
	Serie 49 (2x) Total 195 (9x)		Serie 48 (2x) Total 243 (11x)	
5 ligg		1: 9.9 ↗ 2: 10.6x → 3: 10.4 ↓ 4: 10.6x ↗ 5: 10.3 ↑		
	Serie 49 (2x) Total 292 (13x)			

Skjutlag	Tavla	Mats Kågström		Ligg
1	4	Piteå Skf		
04.07.2020	Tavelträffen gevär Ligg	Piteå Skytteförening		
5 prov		1: 9.1 ↗ 2: 9.7 → 3: 10.6x ↑ 4: 9.4 → 5: 10.5x ←	5 ligg	1: 9.2 ↗ 2: 10.2 ↗ 3: 9.9 ← 4: 10.3 ↗ 5: 9.8 →
		Serie 47 (2x) Total 0 (0x)		Serie 47 (0x) Total 47 (0x)
5 ligg		1: 8.9 ↑ 2: 9.5 ↗ 3: 9.9 → 4: 9.4 ← 5: 10.1 →	5 ligg	1: 8.9 ↗ 2: 10.1 ↗ 3: 10.6x ↓ 4: 10.4 → 5: 9.6 ←
		Serie 45 (0x) Total 92 (0x)		Serie 47 (1x) Total 139 (1x)
4 prov		1: 9.5 ↗ 2: 10.1 ↑ 3: 9.6 ← 4: 7.6 ↖	5 ligg	1: 10.0 ← 2: 10.5x ← 3: 9.8 ← 4: 10.1 ← 5: 9.4 ↗
		Serie 35 (0x) Total 139 (1x)		Serie 48 (1x) Total 187 (2x)
5 ligg		1: 9.3 ↗ 2: 10.4x ↗ 3: 7.5 ↗ 4: 10.4 ↗ 5: 10.1 ↓	5 ligg	1: 7.6 ↗ 2: 10.2 ↓ 3: 10.7x ↗ 4: 10.6x ↗ 5: 9.7 ←
		Serie 46 (1x) Total 233 (3x)		Serie 46 (2x) Total 279 (5x)

Skjutlag	Tavla	Alf Edin		Pskf	Ale Skf	Ligg
1	5			04.07.2020	Tavelträffen gevär Ligg	Piteå Skytteförening
5 prov		1: 9.1 ↓	5 ligg		1: 8.5 ↑	
		2: 9.5 ↓			2: 10.7x →	
		3: 8.8 ↑			3: 10.7x →	
		4: 10.4 ↓			4: 10.7x ↑	
		5: 7.7 ↓			5: 8.2 ↓	
	Serie 43 (0x)			Serie 46 (3x)		
	Total 0 (0x)			Total 46 (3x)		
5 ligg		1: 10.3 ↑	5 ligg		1: 9.7 ←	
		2: 8.4 ←			2: 10.0 ←	
		3: 10.1 ←			3: 9.1 ↓	
		4: 9.9 ↑			4: 10.1 ↓	
		5: 9.5 ←			5: 9.7 ↑	
	Serie 46 (0x)			Serie 47 (0x)		
	Total 92 (3x)			Total 139 (3x)		
4 prov		1: 7.3 ↓	5 ligg		1: 9.0 ↑	
		2: 9.9 ↑			2: 10.1 ↑	
		3: 10.3 ←			3: 9.2 ↓	
		4: 10.1 ↓			4: 10.3 ↓	
	Serie 36 (0x)			Serie 47 (0x)		
	Total 139 (3x)			Total 186 (3x)		
5 ligg		1: 8.5 ↑	5 ligg		1: 9.5 ↓	
		2: 9.0 →			2: 8.1 ↑	
		3: 9.7 →			3: 9.4 →	
		4: 9.4 →			4: 9.4 ↑	
		5: 9.8 ↓			5: 8.6 ←	
	Serie 44 (0x)			Serie 43 (0x)		
	Total 230 (3x)			Total 273 (3x)		

Skjutlag	Tavla	Harry Östling			
1	6			F21 Skf	Ligg
04.07.2020		Tavelträffen gevär Ligg		Piteå Skytteförening	
5 prov		1: 9.0 →	5 ligg		1: 10.1 ←
		2: 9.2 ↓			2: 9.8 →
		3: 10.7x ↓			3: 10.3 →
		4: 10.5x ↑			4: 10.3 →
		5: 10.3 ←			5: 10.4 ↓
		Serie 48 (2x)			Serie 49 (0x)
		Total 0 (0x)			Total 49 (0x)
5 ligg		1: 10.3 ↖	5 ligg		1: 10.0 ↗
		2: 10.1 ←			2: 10.2 ↗
		3: 10.7x ←			3: 10.8x →
		4: 10.0 ↓			4: 10.8x ↓
		5: 10.6x ↗			5: 10.2 ↓
		Serie 50 (2x)			Serie 50 (2x)
		Total 99 (2x)			Total 149 (4x)
4 prov		1: 9.6 ↓	5 ligg		1: 9.5 ↑
		2: 10.1 →			2: 9.9 ↓
		3: 9.5 ↑			3: 10.9x ←
		4: 10.5x →			4: 10.3 ←
					5: 10.3 →
		Serie 38 (1x)			Serie 48 (1x)
		Total 149 (4x)			Total 197 (5x)
5 ligg		1: 9.2 ↑	5 ligg		1: 9.2 ↗
		2: 9.8 ↗			2: 10.0 ↗
		3: 9.8 ↑			3: 10.3 ↓
		4: 9.9 ↓			4: 9.4 ↗
		5: 9.9 ↓			5: 9.3 ←
		Serie 45 (0x)			Serie 47 (0x)
		Total 242 (5x)			Total 289 (5x)

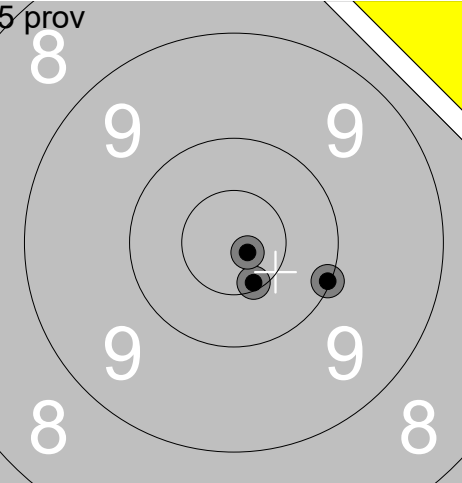
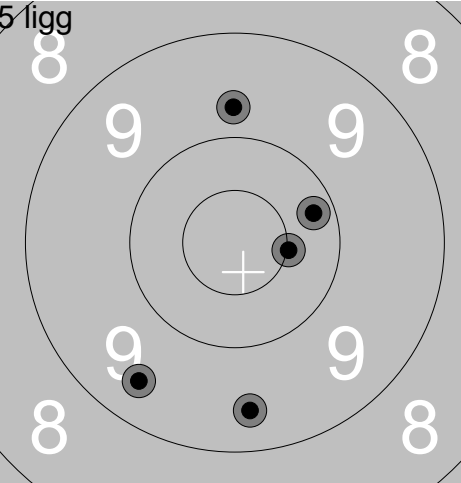
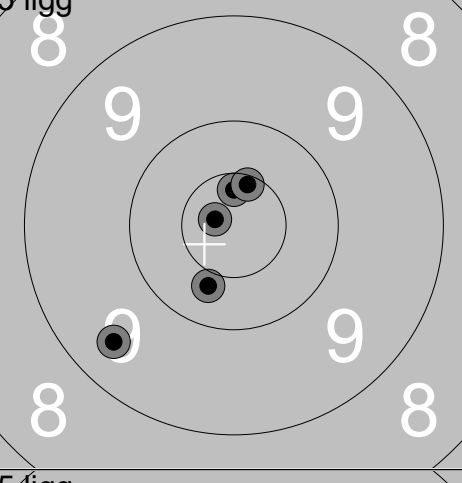
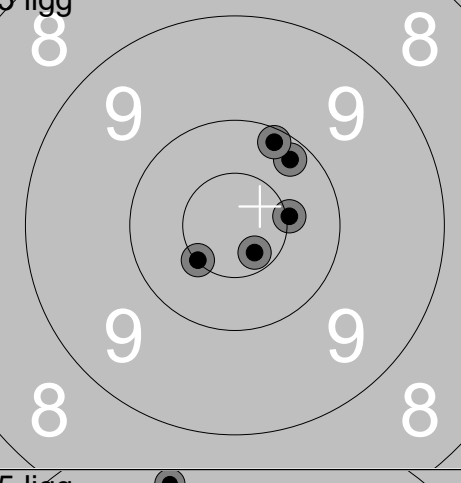
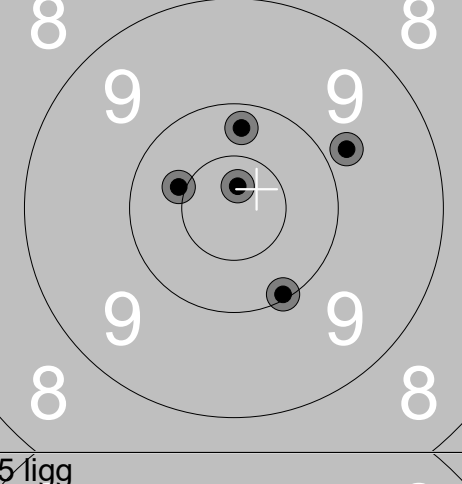
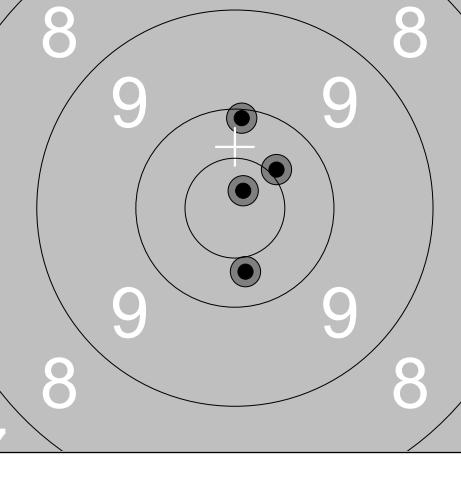
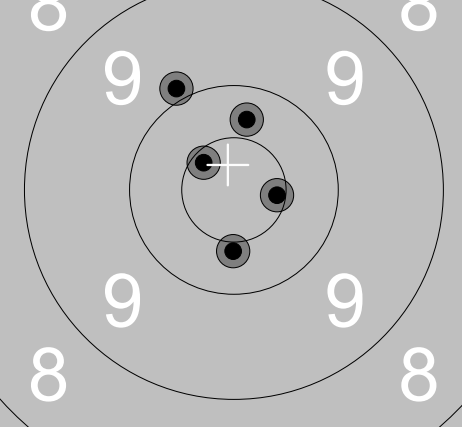
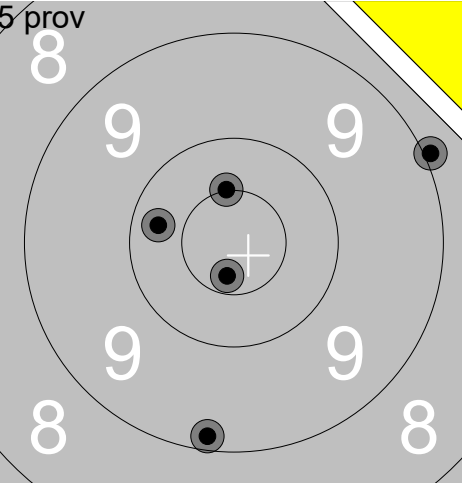
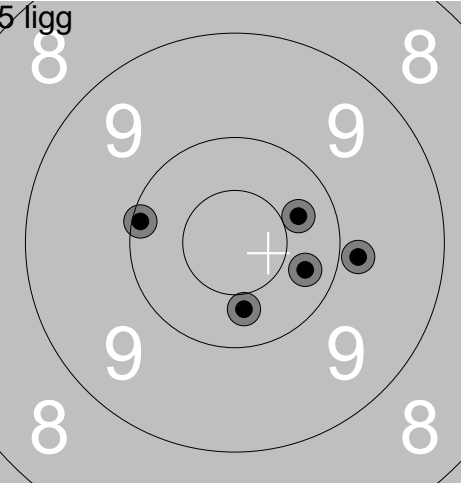
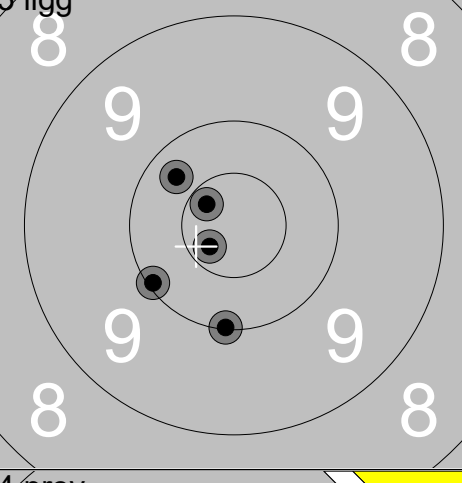
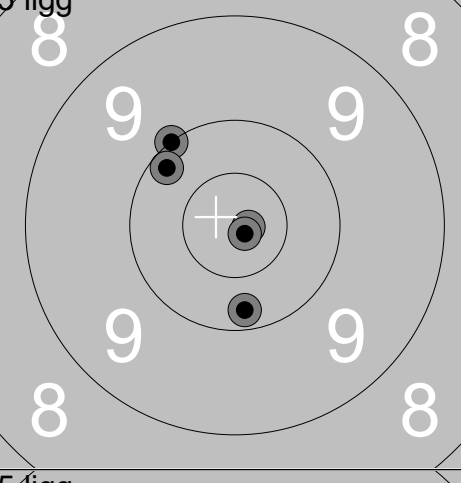
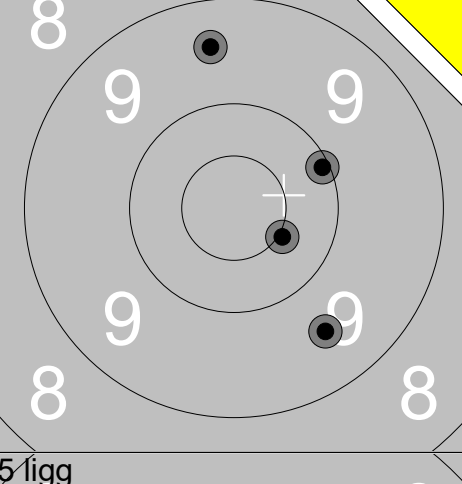
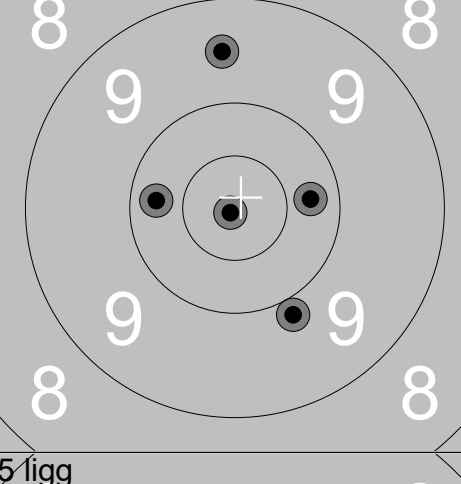
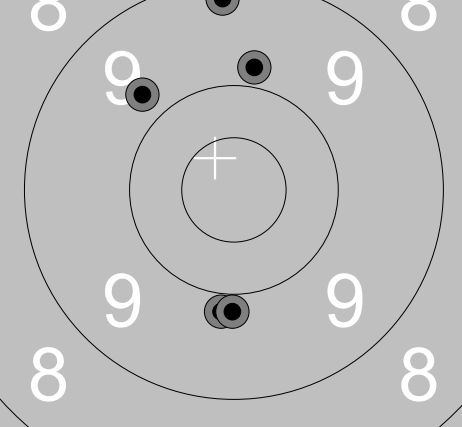
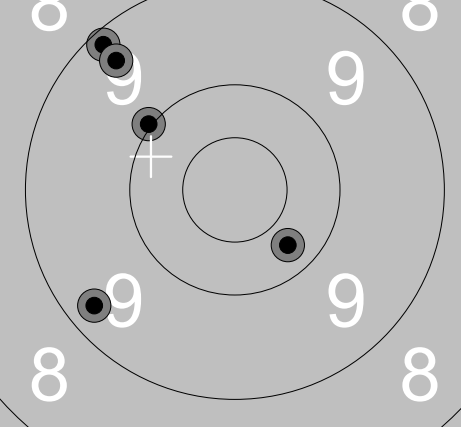
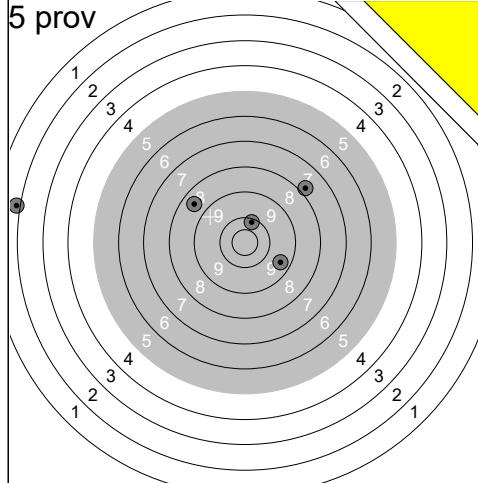

1:	1.9	←
2:	7.8	↗
3:	9.4	→
4:	10.2	↑
5:	8.5	↗
Serie	35 (0x)	
Total	0 (0x)	

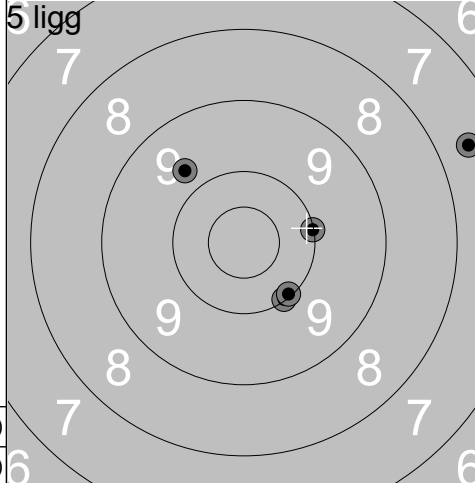

1:	9.7	↗
2:	10.0	↘
3:	10.1	↘
4:	7.6	→
5:	10.0	→
Serie	46 (0x)	
Total	46 (0x)	

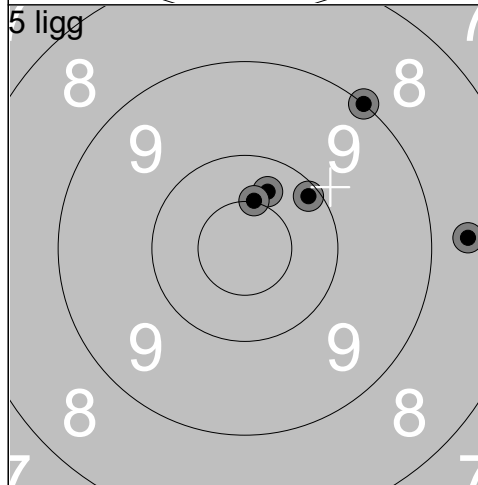

1:	10.3	↑
2:	9.0	↗
3:	8.6	→
4:	10.1	↗
5:	10.5x	↑
Serie	47 (1x)	
Total	93 (1x)	

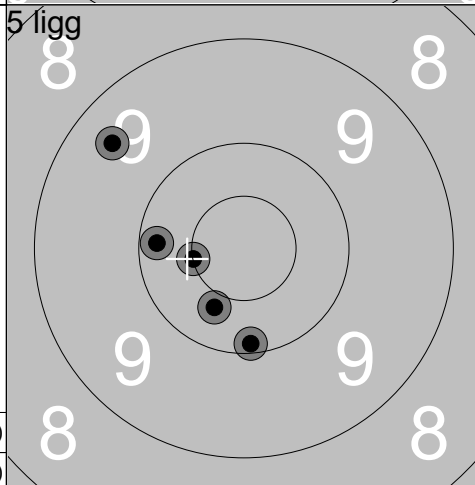

1:	9.4	↖
2:	10.2	←
3:	10.4	↘
4:	10.5x	←
5:	10.1	↘
Serie	49 (1x)	
Total	142 (2x)	

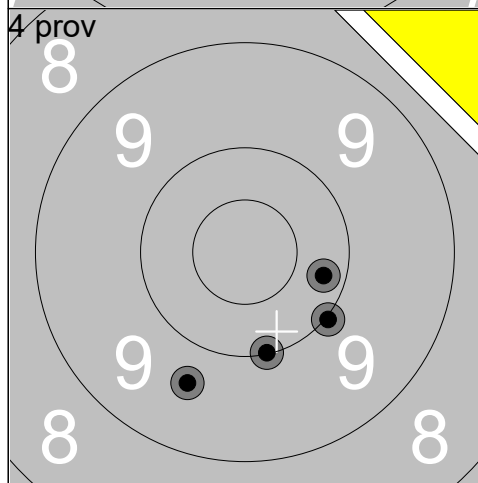

1:	10.0	↘
2:	9.7	↘
3:	10.2	↗
4:	10.0	↘
Serie	39 (0x)	
Total	142 (2x)	

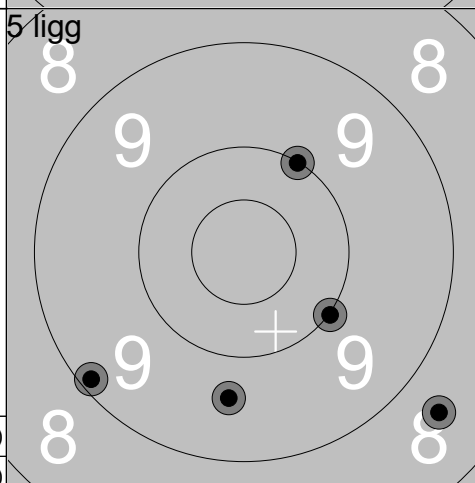

1:	10.0	↘
2:	9.6	↘
3:	9.1	↖
4:	10.0	↑
5:	8.6	↘
Serie	46 (0x)	
Total	188 (2x)	

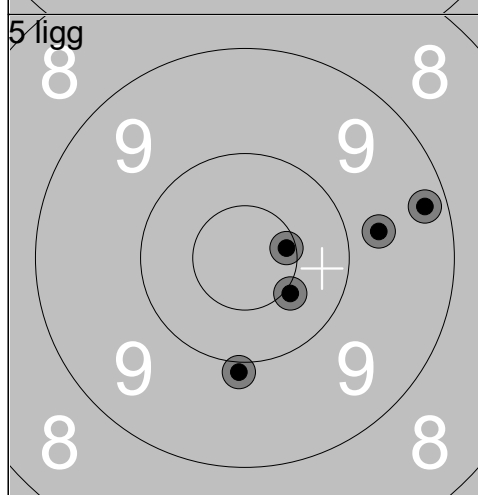

1:	9.7	→
2:	9.2	→
3:	9.9	↘
4:	10.4x	↘
5:	10.6x	→
Serie	47 (2x)	
Total	235 (4x)	

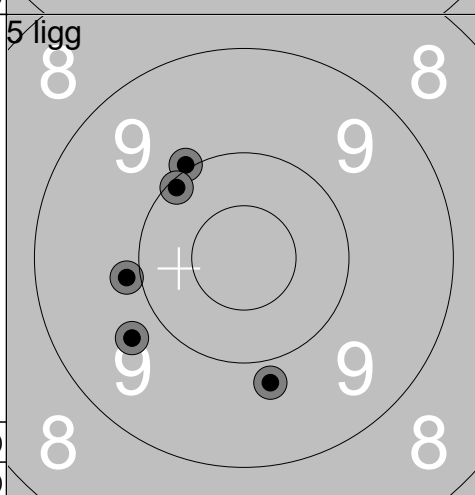

1:	9.8	↘
2:	10.0	↗
3:	10.1	↗
4:	9.9	←
5:	9.7	↖
Serie	47 (0x)	
Total	282 (4x)	

Skjutlag	Tavla	Martin Blombäck	
1	8	Piteå Skf	Ligg
04.07.2020	Tavelträffen gevär Ligg	Piteå Skytteförening	
5 prov		1: 10.1 ↘ 2: 8.7 ↘ 3: 9.7 ↘ 4: 9.5 ↘ 5: 10.7x ↘	5 ligg  1: 9.3 ↗ 2: 9.8 ↘ 3: 10.5x ↘ 4: 9.9 ↗ 5: 10.7x ←
		Serie 46 (1x) Total 0 (0x)	Serie 47 (2x) Total 47 (2x)
5 ligg		1: 10.7x ↗ 2: 9.0 ↗ 3: 9.1 ↘ 4: 9.9 ↘ 5: 10.3 ↗	5 ligg  1: 9.2 ↗ 2: 10.0 ↗ 3: 8.8 ↗ 4: 9.5 ↗ 5: 9.8 ↘
		Serie 47 (1x) Total 94 (3x)	Serie 45 (0x) Total 139 (3x)
4 prov		1: 10.1 ← 2: 9.6 → 3: 10.5x ← 4: 10.1 →	5 ligg  1: 10.0 ↗ 2: 9.6 ↗ 3: 10.6x → 4: 10.2 ↗ 5: 10.2 ↗
		Serie 39 (1x) Total 139 (3x)	Serie 49 (1x) Total 188 (4x)
5 ligg		1: 10.6x ↗ 2: 9.6 ↗ 3: 10.5x ↗ 4: 8.7 ↗ 5: 8.9 ↗	5 ligg  1: 8.9 ↗ 2: 8.9 ↘ 3: 6.9 ↗ 4: 10.1 ↗ 5: 9.0 ↗
		Serie 45 (2x) Total 233 (6x)	Serie 41 (0x) Total 274 (6x)

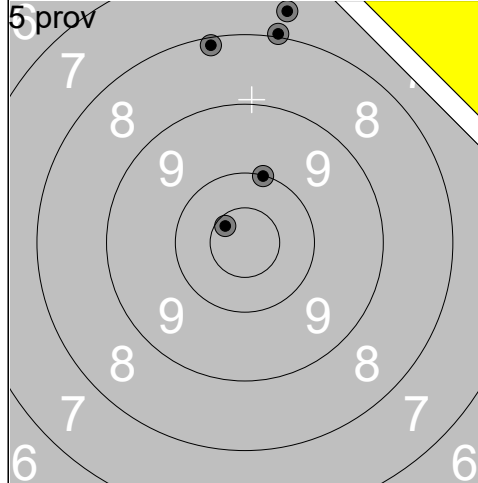

1:	8.0	↑
2:	8.1	↑
3:	10.0	↑
4:	7.6	↑
5:	10.6x	↖
Serie		43 (1x)
Total		0 (0x)

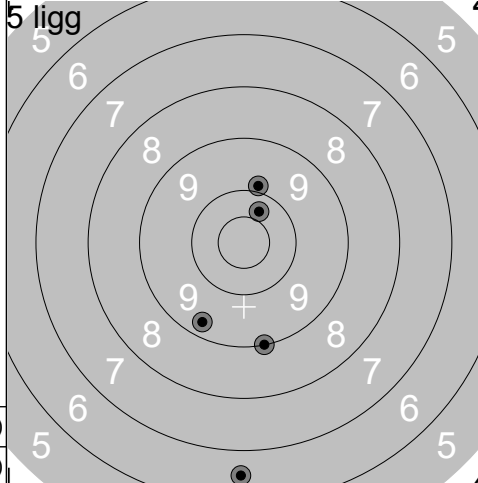

1:	10.3	↗
2:	9.3	↘
3:	6.6	↘
4:	9.9	↑
5:	9.0	↘
Serie		43 (0x)
Total		43 (0x)

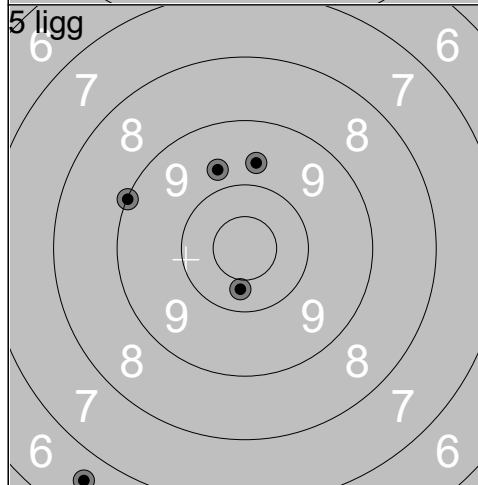

1:	9.0	↖
2:	6.6	↘
3:	9.7	↑
4:	10.4	↘
5:	9.7	↗
Serie		43 (0x)
Total		86 (0x)

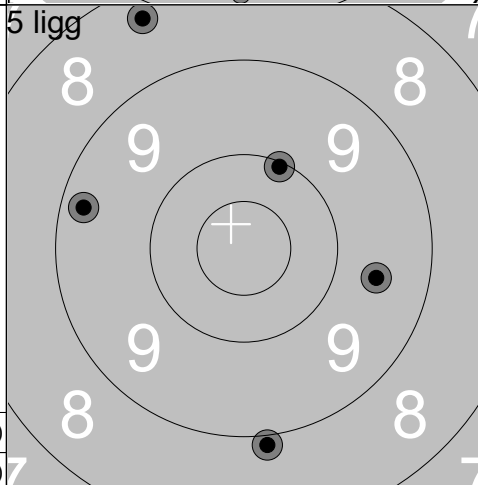

1:	9.6	→
2:	10.1	↑
3:	9.3	↖
4:	8.9	↘
5:	8.4	↗
Serie		44 (0x)
Total		130 (0x)

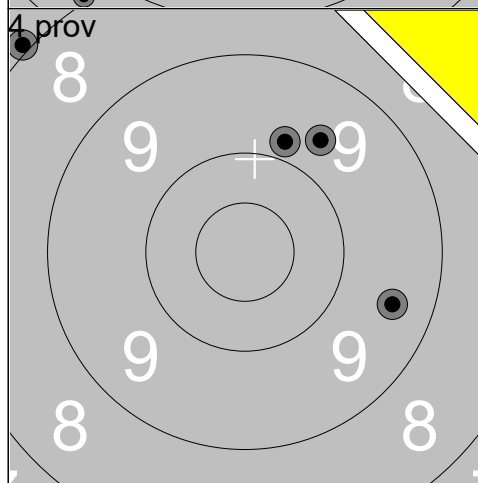

1:	9.7	↗
2:	9.8	↑
3:	9.4	→
4:	8.0	↗
Serie		35 (0x)
Total		130 (0x)

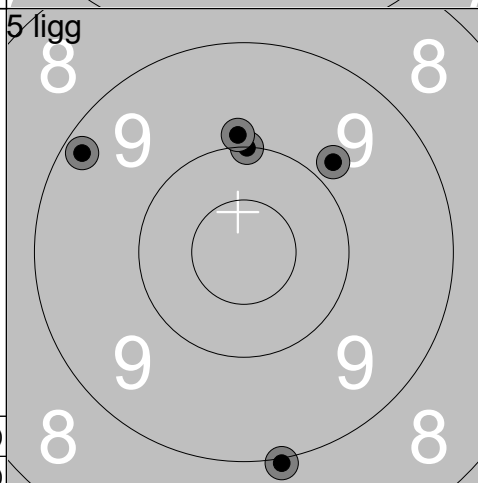

1:	10.0	↑
2:	9.0	↘
3:	9.9	↑
4:	9.8	↗
5:	9.2	↖
Serie		46 (0x)
Total		176 (0x)

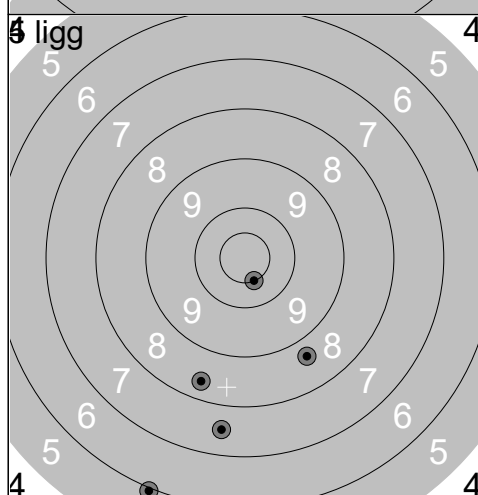

1:	8.7	↘
2:	7.5	↘
3:	6.0	↘
4:	8.4	↘
5:	10.5x	↘
Serie		39 (1x)
Total		215 (1x)

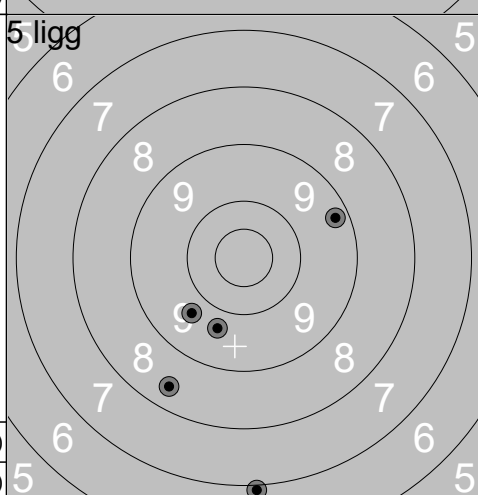

1:	9.7	↘
2:	6.9	↘
3:	9.3	→
4:	9.7	↘
5:	8.4	↘
Serie		41 (0x)
Total		256 (1x)

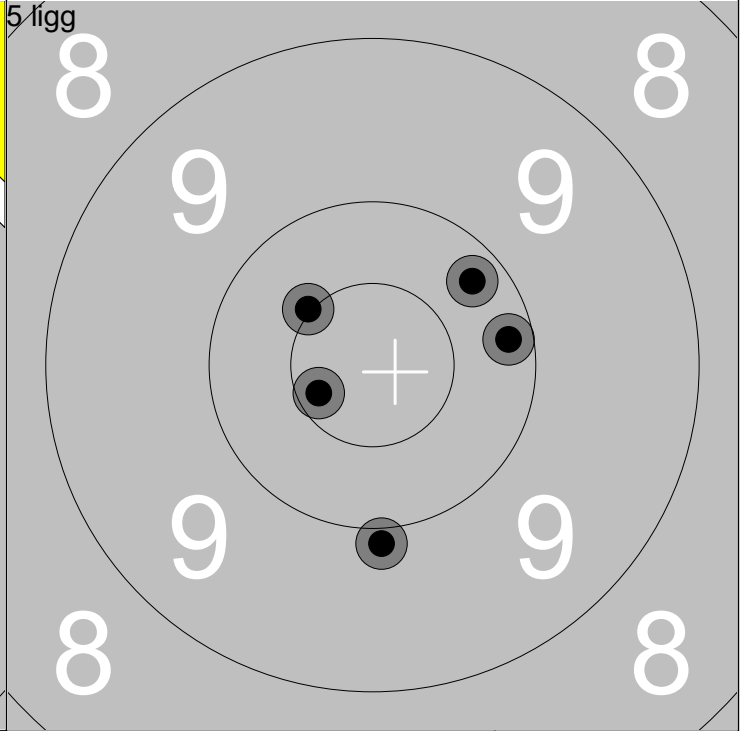
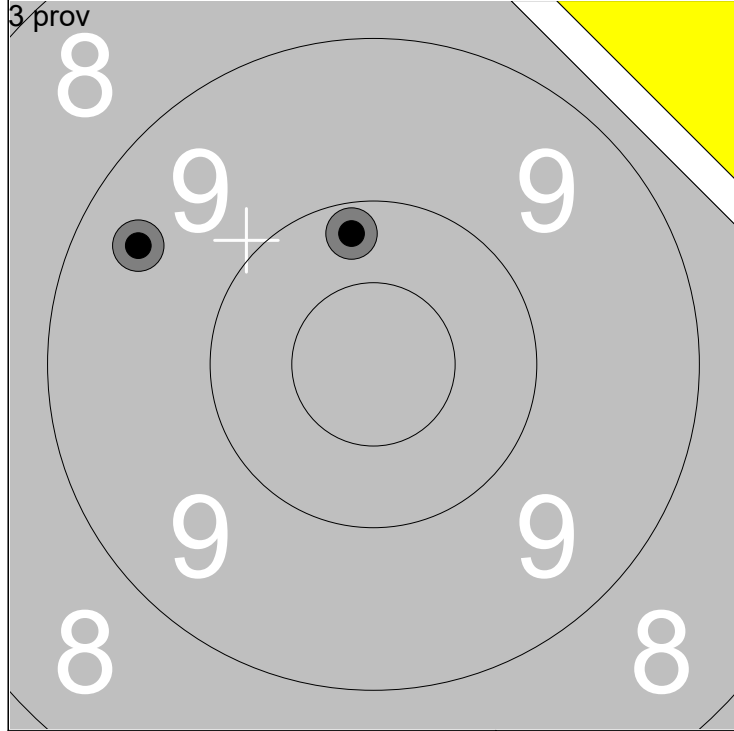

1: 9.4 ↖	Serie	19 (0x)
2: 10.2 ↑		
Total		292 (0x)

1: 9.9 ↓	Serie	49 (2x)
2: 10.2 →		
3: 10.5x ↖		
4: 10.2 ↗		
5: 10.6x ↖		
Total		341 (2x)

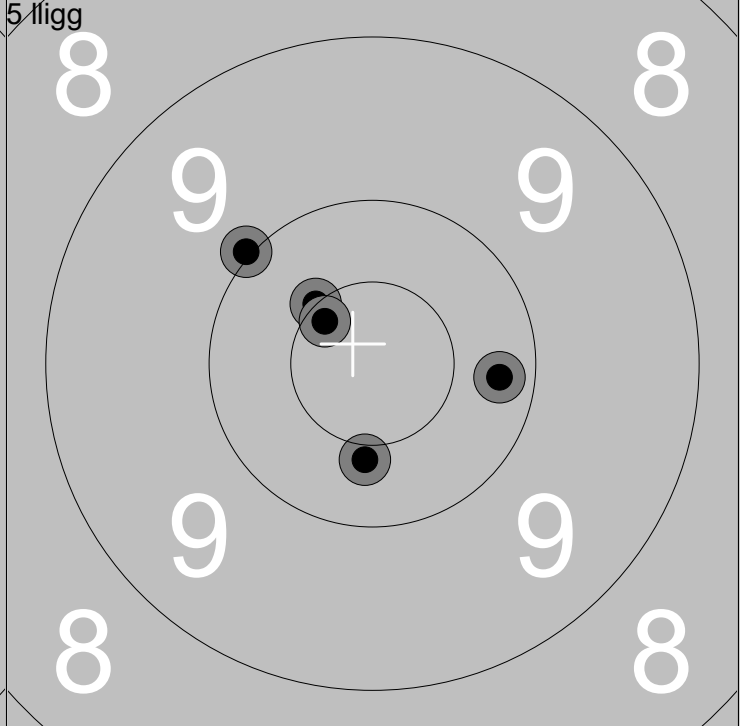
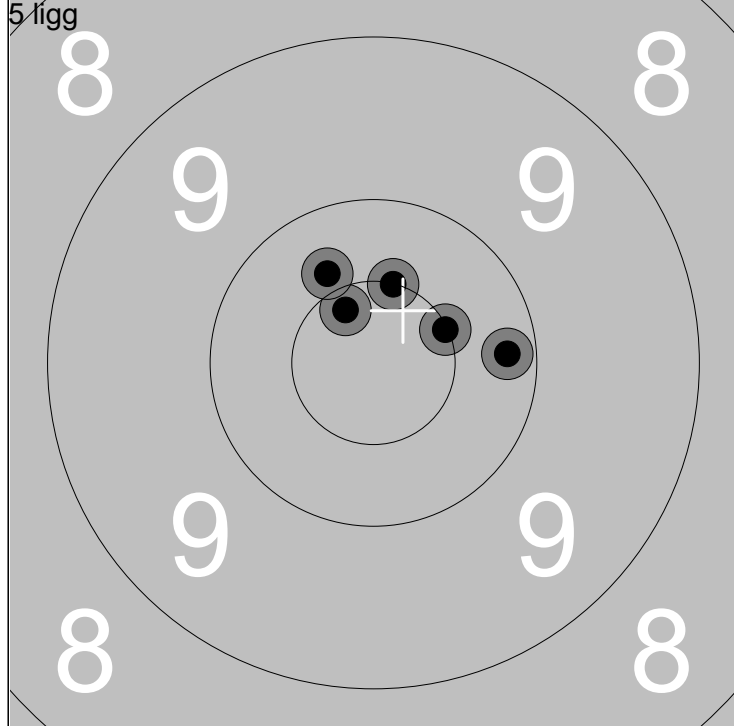

1: 10.5x ↑	Serie	50 (3x)
2: 10.6x ↖		
3: 10.4 ↖		
4: 10.5x ↗		
5: 10.2 →		
Total		391 (5x)

1: 10.2 →	Serie	50 (2x)
2: 10.0 ↖		
3: 10.4 ↓		
4: 10.5x ↖		
5: 10.6x ↖		
Total		441 (7x)



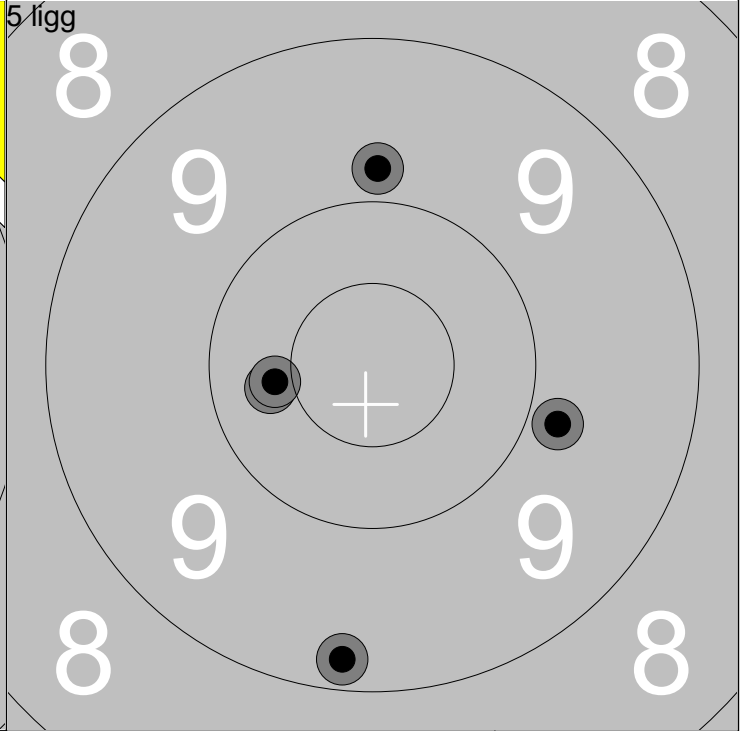
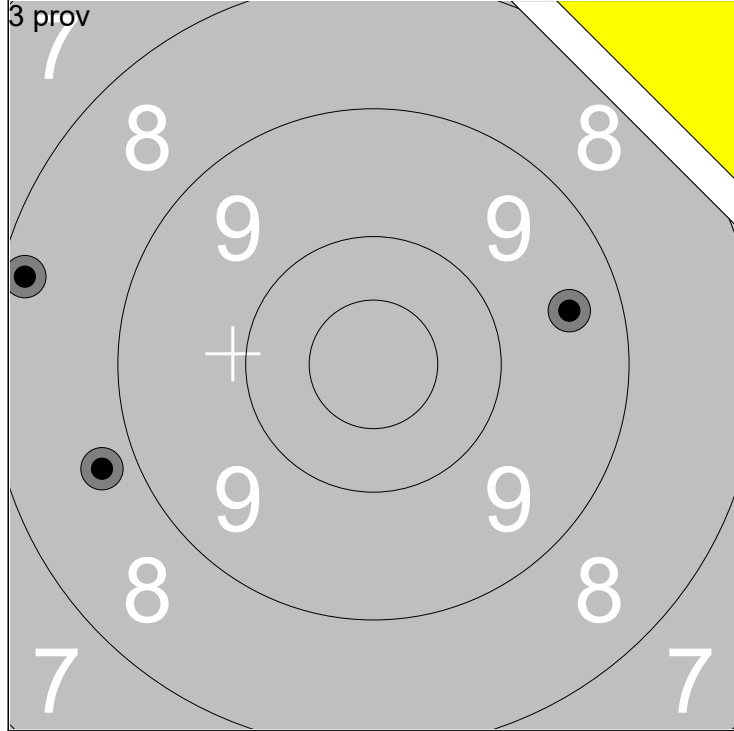

1:	8.2	←
2:	9.4	→
3:	8.8	←

Serie	25 (0x)
Total	279 (0x)

1:	9.8	↑
2:	10.4	←
3:	10.4	←
4:	9.8	→
5:	9.2	↓

Serie	47 (0x)
Total	326 (0x)

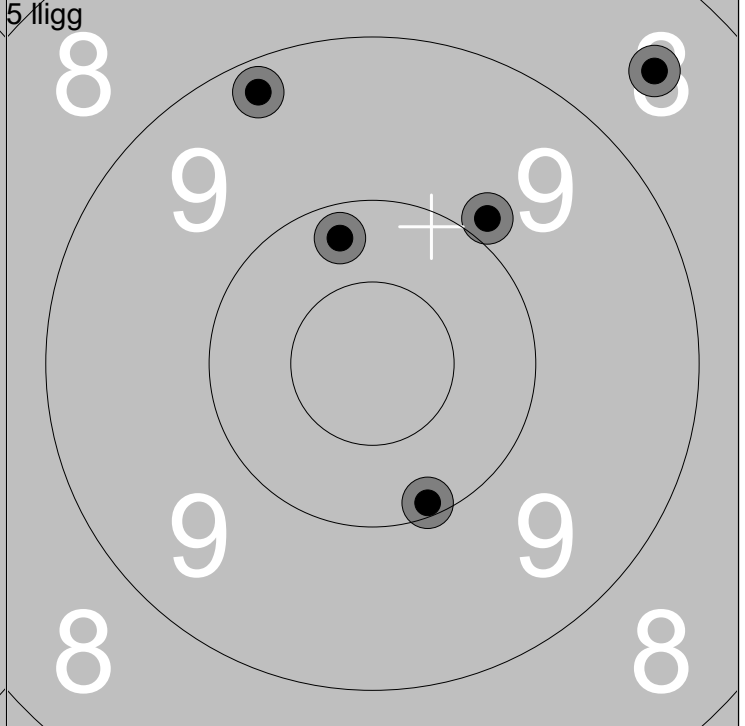
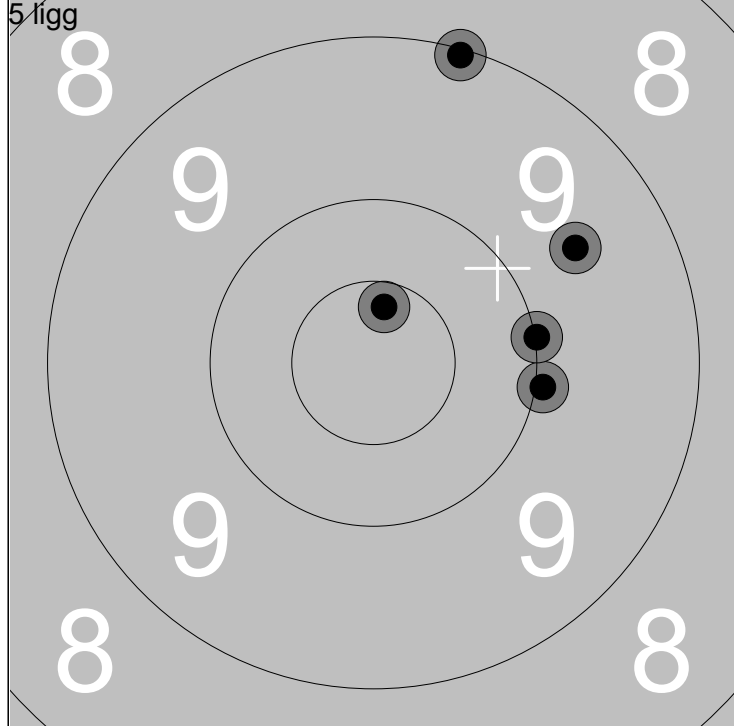

1:	9.6	↗
2:	10.0	→
3:	9.1	↑
4:	10.0	→
5:	10.6x	↑

Serie	48 (1x)
Total	374 (1x)

1:	9.9	↗
2:	9.2	↖
3:	8.5	↗
4:	10.1	↓
5:	10.2	↑

Serie	46 (0x)
Total	420 (1x)

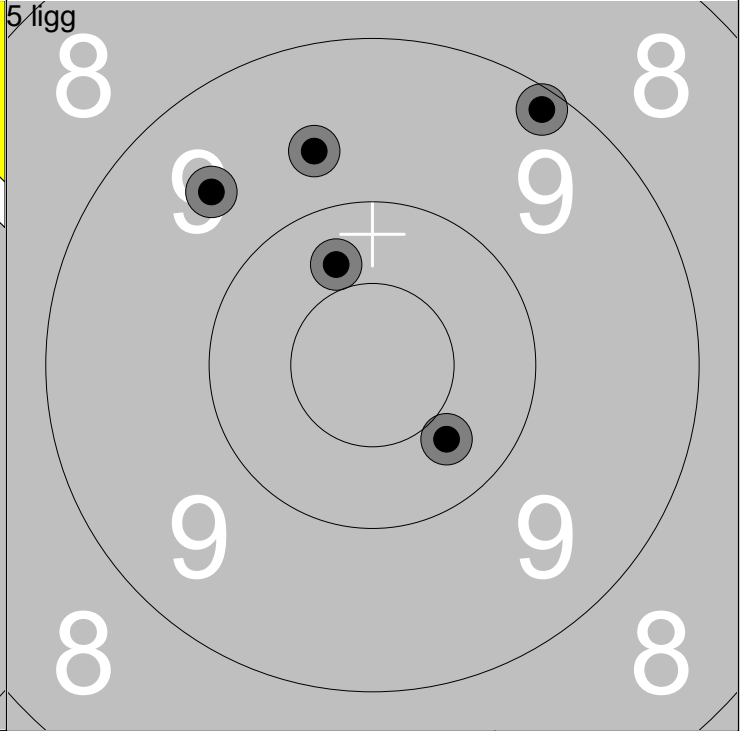
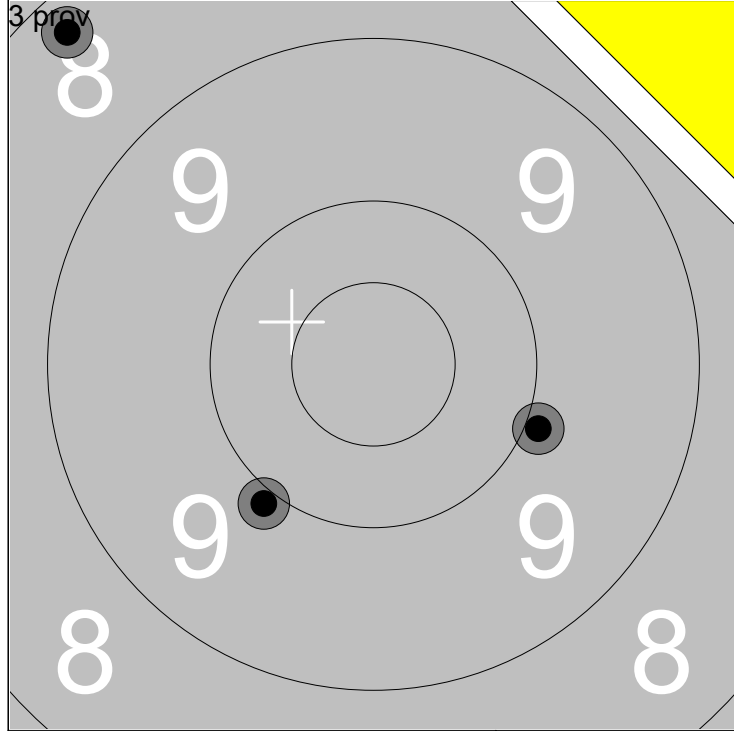

1: 9.9 ↙	Serie	26 (0x)
2: 8.3 ↗		
3: 9.9 ↘		
Total		273 (0x)

1: 9.2 ↗	Serie	47 (0x)
2: 9.7 ↗		
3: 9.6 ↗		
4: 10.3 ↗		
5: 10.4 ↘		
Total		320 (0x)

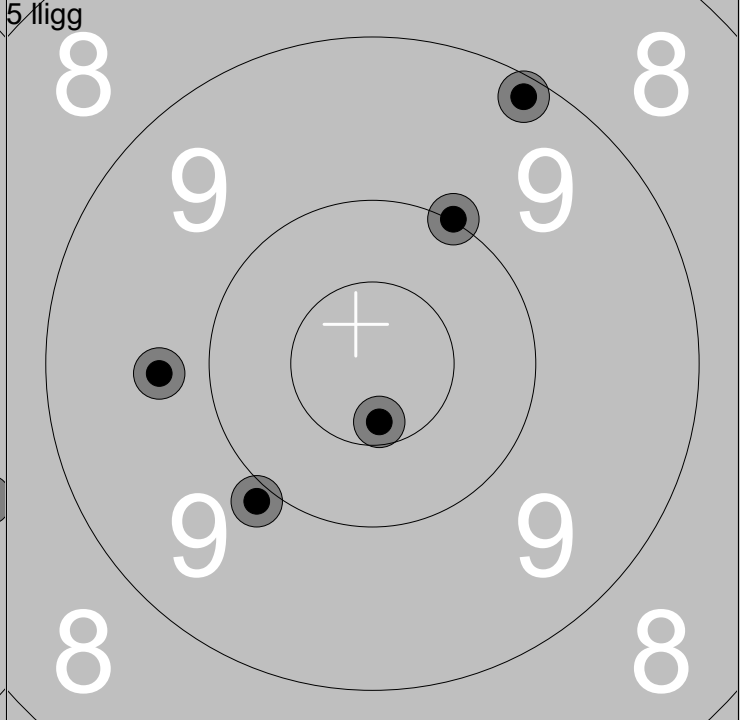
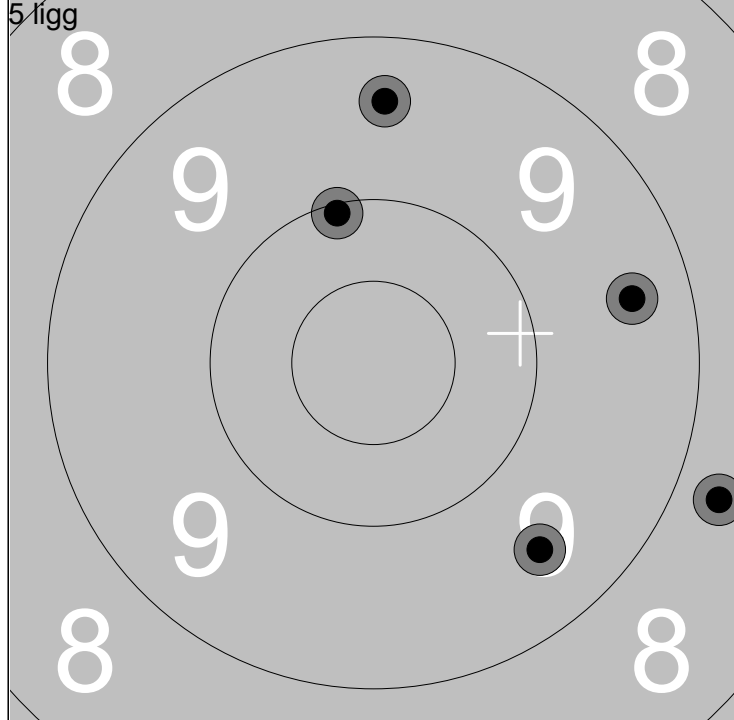

1: 8.7 →	Serie	45 (0x)
2: 9.5 ↘		
3: 10.1 ↗		
4: 9.4 ↑		
5: 9.4 →		
Total		365 (0x)

1: 9.2 ↗	Serie	47 (1x)
2: 9.9 ↙		
3: 9.7 ←		
4: 10.6x ↘		
5: 10.0 ↗		
Total		412 (1x)

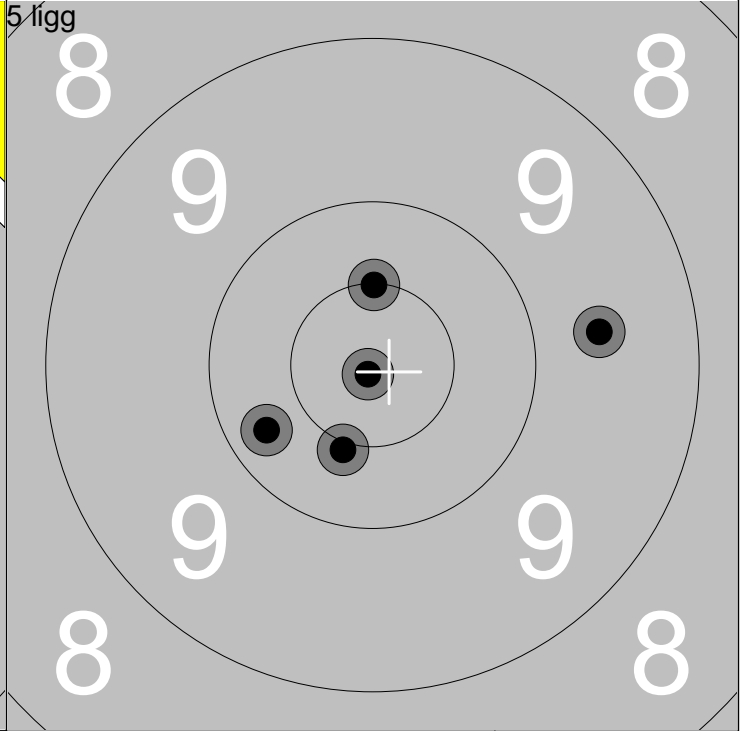
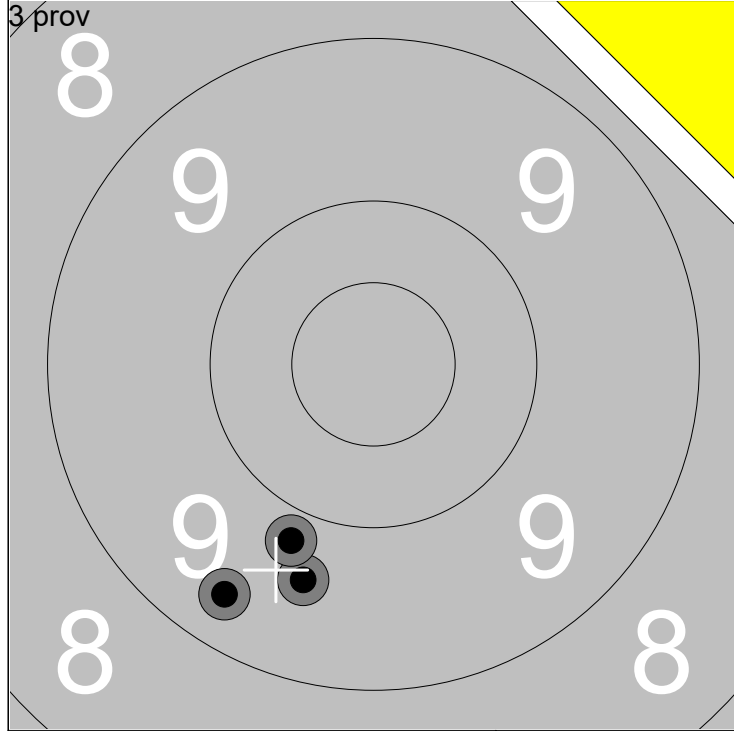

1: 9.6 ↓	Serie	27 ( 0x)
2: 9.8 ↓		
3: 9.3 ↓		
Total		289 ( 0x)

1: 9.6 →	Serie	49 ( 3x)
2: 10.5x ↑		
3: 10.9x ↓		
4: 10.4x ↓		
5: 10.2 ↙		
Total		338 ( 3x)

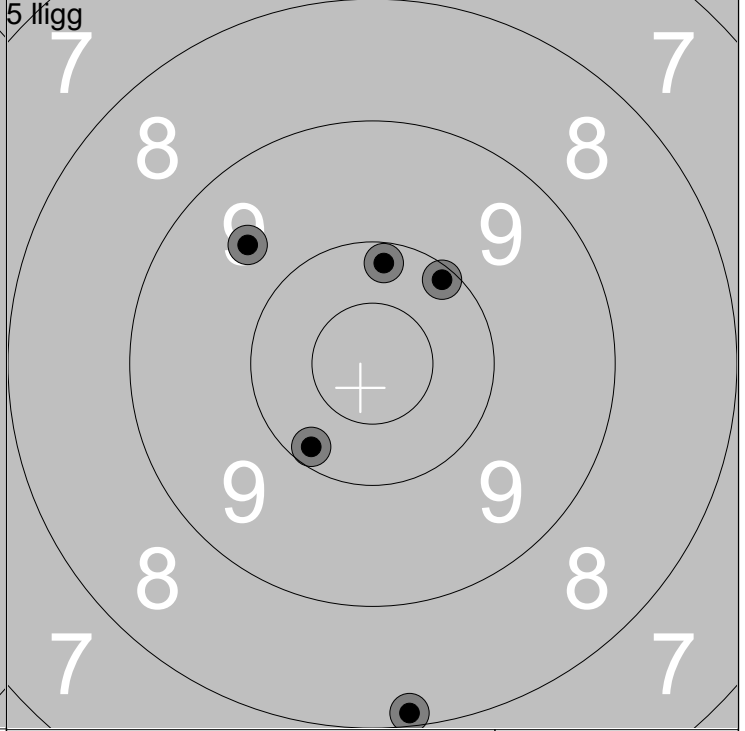
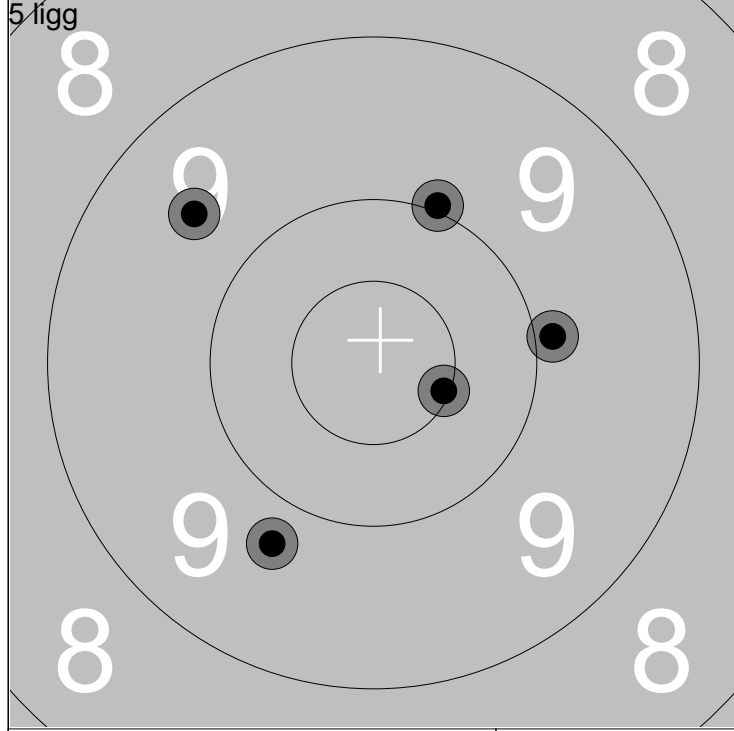

1: 9.6 ↖	Serie	47 ( 1x)
2: 10.5x →		
3: 10.0 ↑		
4: 9.9 →		
5: 9.8 ↓		
Total		385 ( 4x)

1: 9.6 ↖	Serie	47 ( 0x)
2: 10.2 ↑		
3: 10.1 ↗		
4: 10.2 ↓		
5: 8.1 ↓		
Total		432 ( 4x)

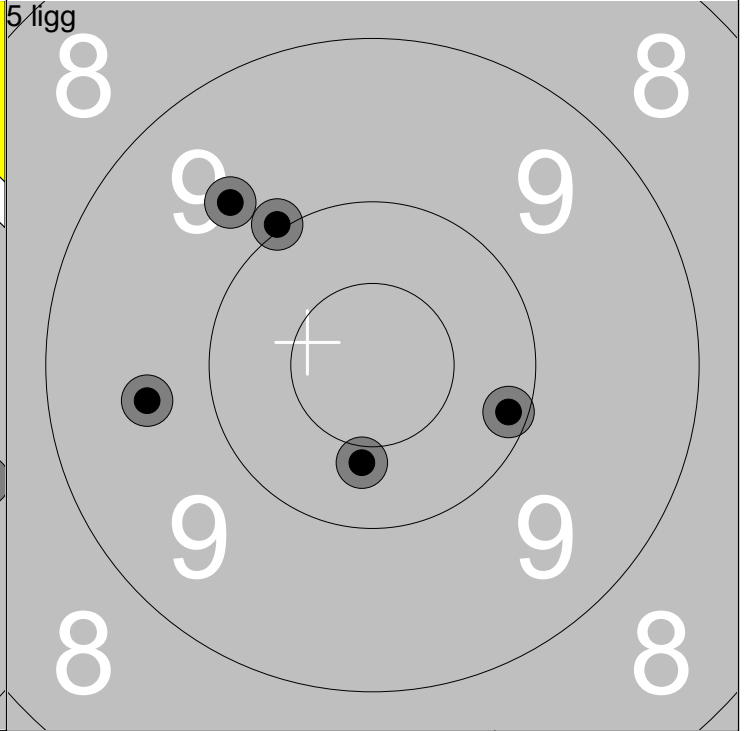
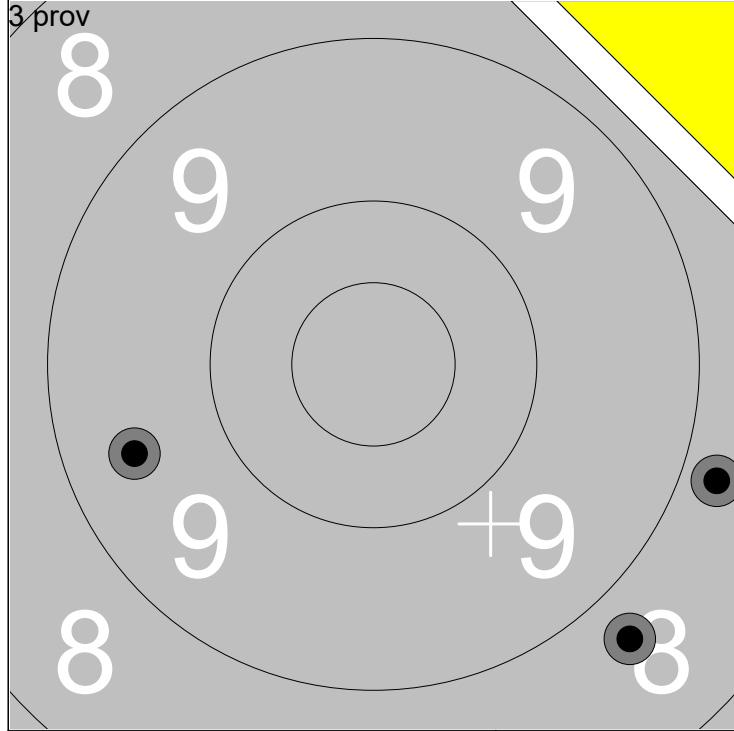

1:	8.7	↘			
2:	8.8	↘			
3:	9.5	←			
			Serie	25 (0x)	
			Total	282 (0x)	

1:	10.1	→			
2:	9.7	↗			
3:	10.0	↗			
4:	10.4	↓			
5:	9.6	←			
			Serie	48 (0x)	
			Total	330 (0x)	

1:	10.1	→			
2:	9.7	↗			
3:	10.0	↗			
4:	10.4	↓			
5:	9.6	←			
			Serie	48 (0x)	
			Total	330 (0x)	

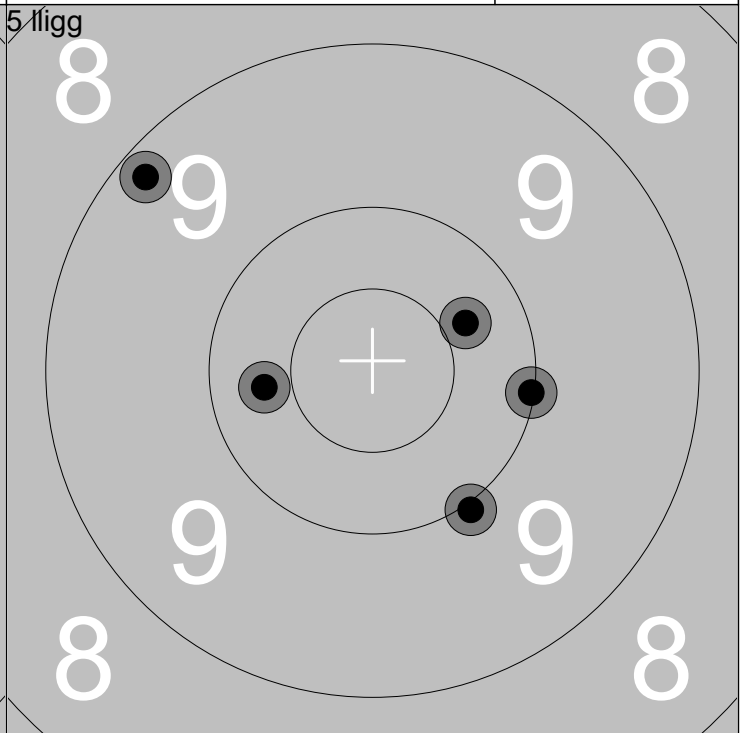
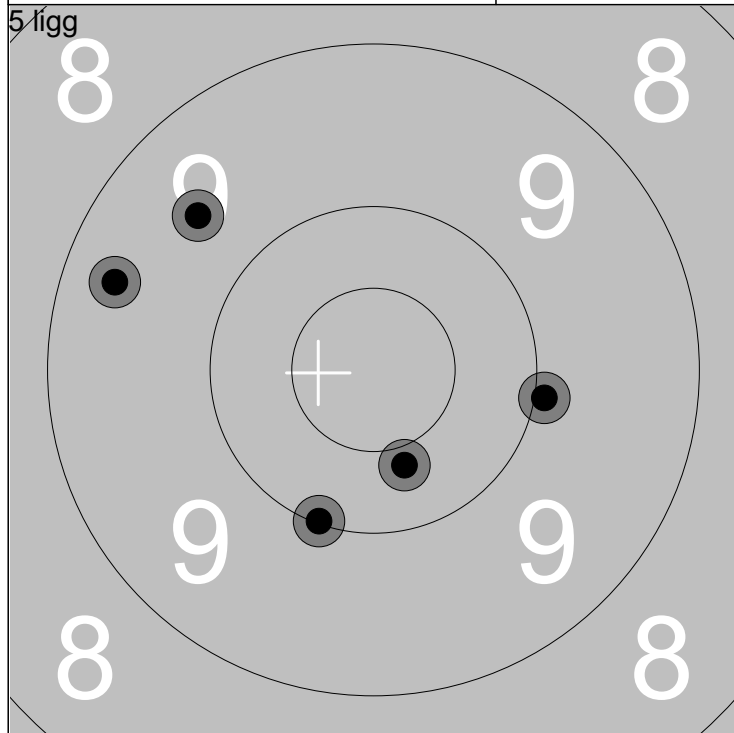

1:	10.4	↓			
2:	9.4	↖			
3:	9.6	↗			
4:	10.0	↓			
5:	10.0	→			
			Serie	48 (0x)	
			Total	378 (0x)	

1:	10.0	↓			
2:	10.4	↗			
3:	9.2	↖			
4:	10.3	←			
5:	10.0	→			
			Serie	49 (0x)	
			Total	427 (0x)	

1:	10.0	↓			
2:	10.4	↗			
3:	9.2	↖			
4:	10.3	←			
5:	10.0	→			
			Serie	49 (0x)	
			Total	427 (0x)	

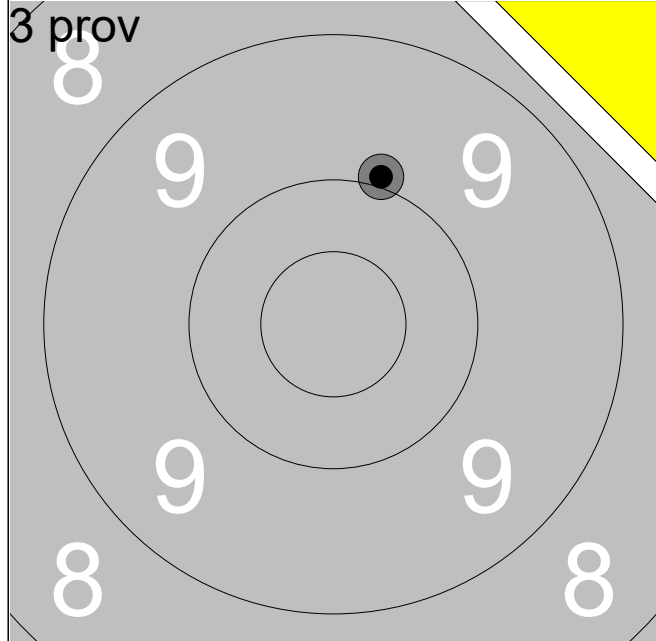

1:	10.0	↑
----	------	---

Serie 10 ( 0x)

Total 274 ( 0x)



1:	9.8	↘
2:	7.6	↓
3:	8.9	↓
4:	9.5	→
5:	8.0	↓

Serie 41 ( 0x)

Total 315 ( 0x)

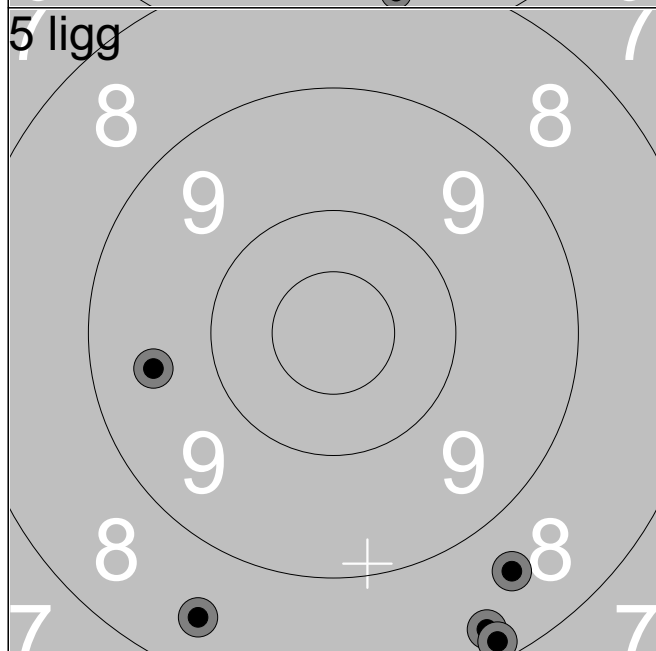

1:	8.6	↘
2:	8.3	↘
3:	9.5	←
4:	8.5	↓
5:	8.2	↓

Serie 41 ( 0x)

Total 356 ( 0x)

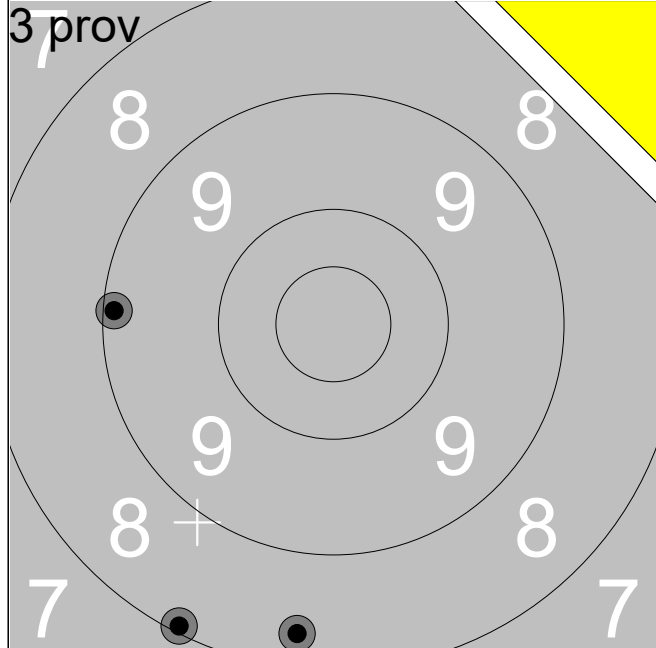

1:	8.1	↘
2:	9.1	←
3:	8.3	↓

Serie	25 ( 0x)
Total	256 ( 0x)

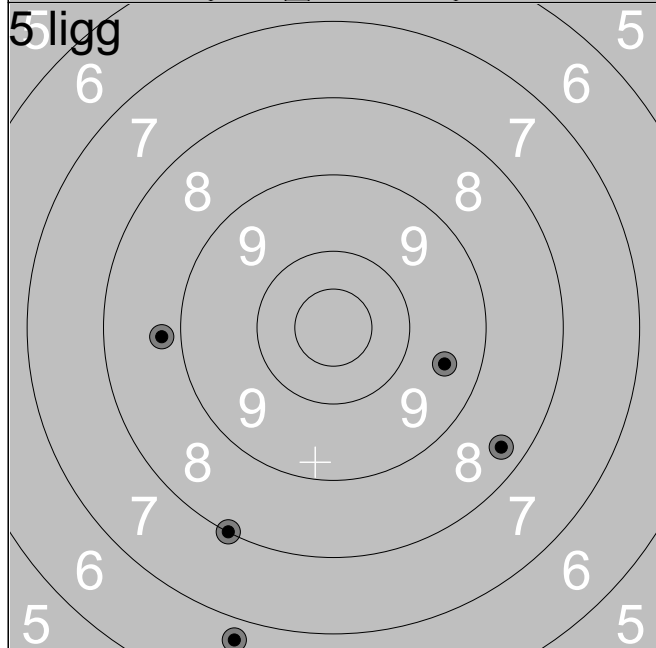

1:	9.5	→
2:	8.8	←
3:	8.0	↓
4:	8.3	↘
5:	6.7	↓

Serie	39 ( 0x)
Total	295 ( 0x)



1:	6.8	↑
2:	10.0	↘
3:	10.5x	→

Serie	26 ( 1x)
Total	321 ( 1x)

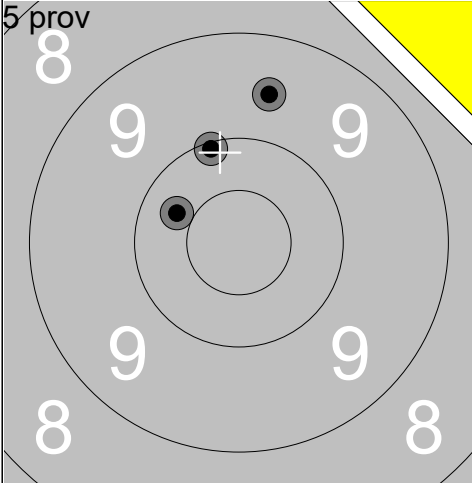
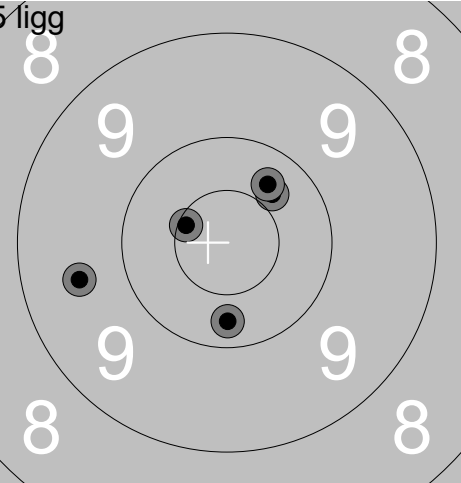
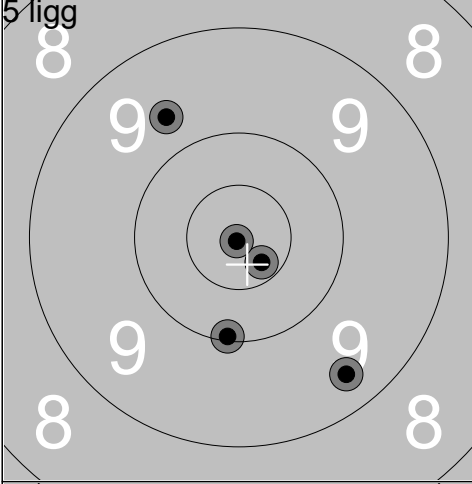
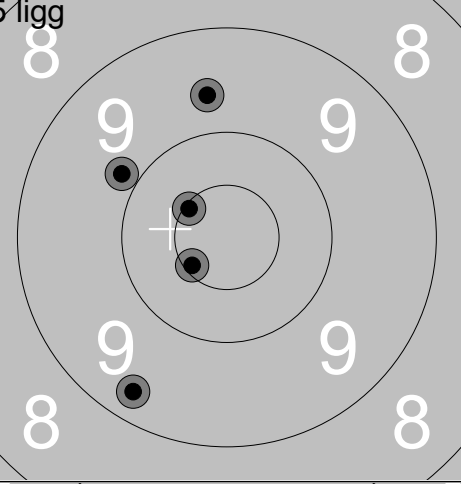
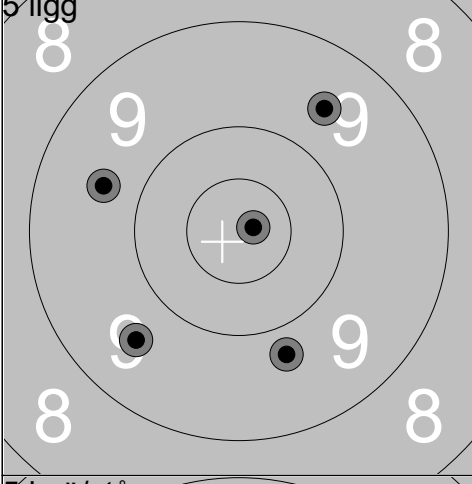
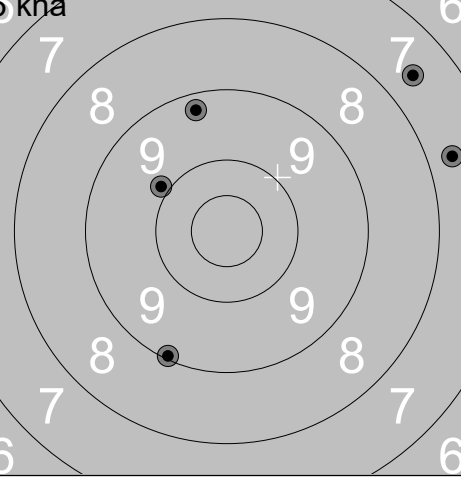
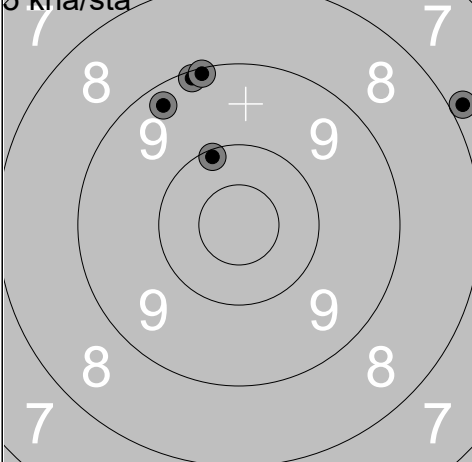
Skjutlag <b>1</b>	Tavla <b>3</b>	<b>Håkan Lidman</b>	
Pskf		Piteå Skf	
04.07.2020		Tavelträffen gevär ställning	Piteå Skytteförening
5 prov		1: 10.3 ↖ 2: 10.1 ↗ 3: 9.6 ↗	5 ligg
		Serie 29 (0x) Total 0 (0x)	
			1: 10.4 ↗ 2: 10.3 ↗ 3: 10.6x ↖ 4: 9.6 ← 5: 10.3 ↓
			Serie 49 (1x) Total 49 (1x)
5 ligg		1: 10.1 ↓ 2: 9.4 ↓ 3: 9.7 ↗ 4: 10.6x ↓ 5: 10.9x ↓	5 ligg
		Serie 48 (2x) Total 97 (3x)	
			1: 10.5x ↖ 2: 9.9 ↖ 3: 9.7 ↗ 4: 10.6x ↖ 5: 9.3 ↓
			Serie 47 (2x) Total 144 (5x)
5 ligg		1: 9.8 ↓ 2: 9.6 ↗ 3: 9.6 ↖ 4: 9.7 ↖ 5: 10.8x →	5 knä
		Serie 46 (1x) Total 190 (6x)	
			1: 9.1 ↓ 2: 7.7 → 3: 9.3 ↗ 4: 9.9 ↖ 5: 7.6 ↗
			Serie 41 (0x) Total 231 (6x)
5 knä/stå		1: 7.9 → 2: 9.1 ↗ 3: 10.1 ↗ 4: 9.3 ↗ 5: 9.1 ↗	
		Serie 44 (0x) Total 275 (6x)	

Skjutlag	Tavla	Mats Kågström		
1	4	Piteå Skf	Knä	
04.07.2020	Tavelträffen gevär ställning	Piteå Skytteförening		
5 prov		1: 10.8x ↗ 2: 10.0 ↗ 3: 9.5 ↗ 4: 10.3 ↗ 5: 9.9 ↗	5 ligg 	1: 9.7 ↖ 2: 10.7x ← 3: 10.1 ↗ 4: 9.0 ↖ 5: 9.5 ↖
		Serie 48 (1x)	Serie 47 (1x)	
		Total 0 (0x)	Total 47 (1x)	
5 ligg		1: 10.4x ↗ 2: 10.3 ↗ 3: 10.3 ↗ 4: 10.1 ← 5: 9.4 ←	5 ligg 	1: 8.6 ↗ 2: 9.8 ↑ 3: 10.0 ↗ 4: 10.5x ↓ 5: 10.3 ↓
		Serie 49 (1x)	Serie 47 (1x)	
		Total 96 (2x)	Total 143 (3x)	
4 prov		1: 9.0 ↖ 2: 10.4x ↓ 3: 10.2 ↑ 4: 10.3 ↗	5 ligg 	1: 10.2 ↖ 2: 10.2 → 3: 9.6 ↘ 4: 10.1 ↑ 5: 10.8x ↑
		Serie 39 (1x)	Serie 49 (1x)	
		Total 143 (3x)	Total 192 (4x)	
5 knä		1: 10.0 ↑ 2: 8.2 ↗ 3: 8.7 ← 4: 8.2 ↓ 5: 9.3 ←	5 knä/stå 	1: 9.0 ↖ 2: 8.8 → 3: 8.7 ↘ 4: 8.1 → 5: 9.1 ←
		Serie 43 (0x)	Serie 42 (0x)	
		Total 235 (4x)	Total 277 (4x)	

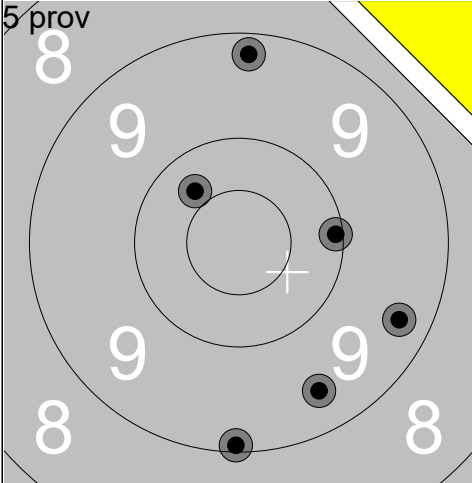
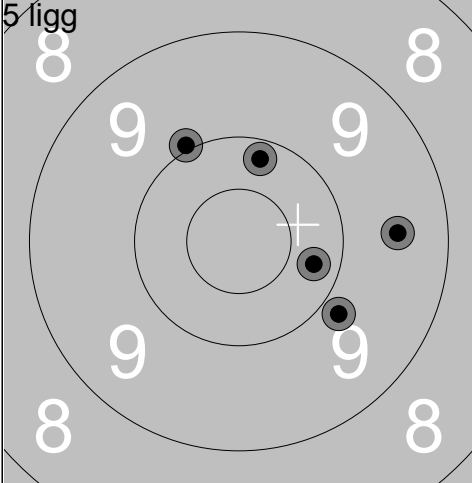
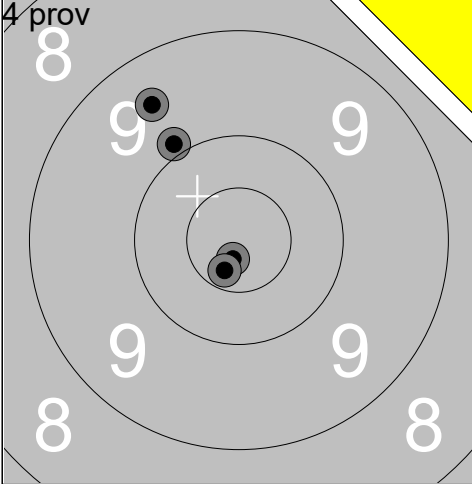
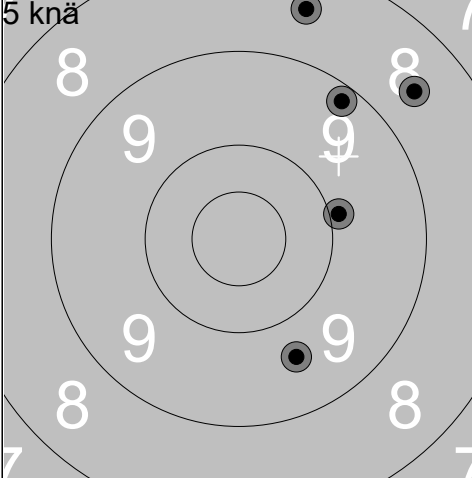

Skjutlag	Tavla	Roger Andersson		
1	5			
Pskf	S3 SolF	Ställning		
04.07.2020	Tavelträffen gevär ställning	Piteå Skytteförening		
5 prov		1: 9.4 ↘ 2: 9.3 ↘ 3: 9.1 ↓ 4: 10.4 ↗ 5: 9.2 ↑ 6: 10.1 →	5 ligg	1: 9.6 ↘ 2: 10.2 ↑ 3: 10.0 ↑ 4: 10.3 ↖ 5: 10.2 ↙
	Serie 56 (0x) Total 0 (0x)		Serie 49 (0x) Total 49 (0x)	
5 ligg		1: 10.2 ↑ 2: 9.9 ↘ 3: 10.3 → 4: 9.5 → 5: 10.0 ↗	5 ligg	1: 9.9 ↑ 2: 10.3 ↖ 3: 10.0 ↓ 4: 10.8x → 5: 10.6x ↑
	Serie 48 (0x) Total 97 (0x)		Serie 49 (2x) Total 146 (2x)	
4 prov		1: 10.8x ↘ 2: 9.5 ↗ 3: 9.9 ↗ 4: 10.7x ↘	5 ligg	1: 10.5x ↑ 2: 9.6 ↑ 3: 10.4x ↑ 4: 9.0 ↑ 5: 10.2 ↑
	Serie 38 (2x) Total 146 (2x)		Serie 48 (2x) Total 194 (4x)	
5 knä		1: 9.6 ↘ 2: 9.9 → 3: 8.6 ↗ 4: 9.2 ↗ 5: 8.5 ↑	5 knä/stå	1: 4.9 ↘ 2: 6.6 ↑ 3: 1.7 ← 4: 6.1 ← 5: 10.4x ↑
	Serie 43 (0x) Total 237 (4x)		Serie 27 (1x) Total 264 (5x)	

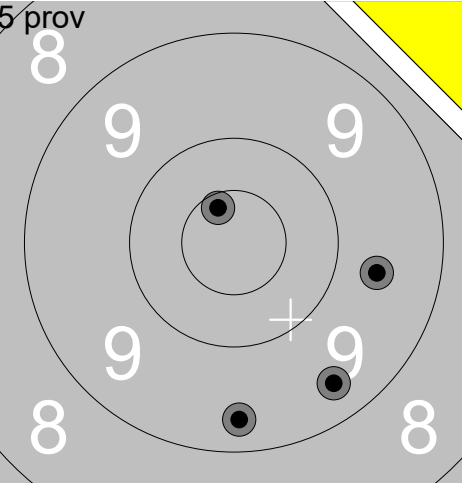
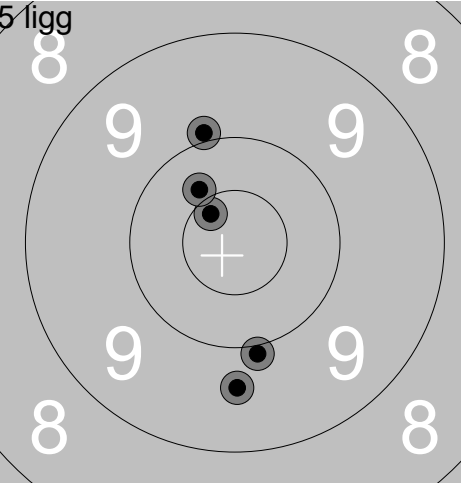
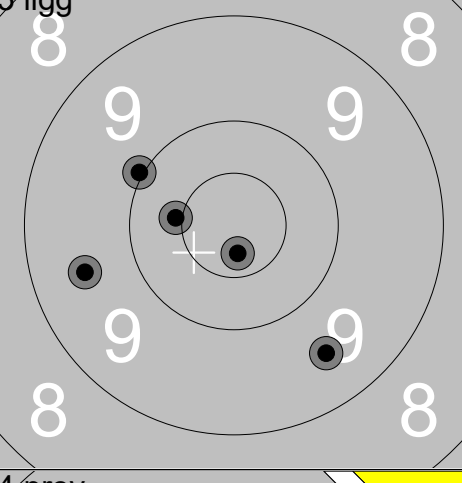
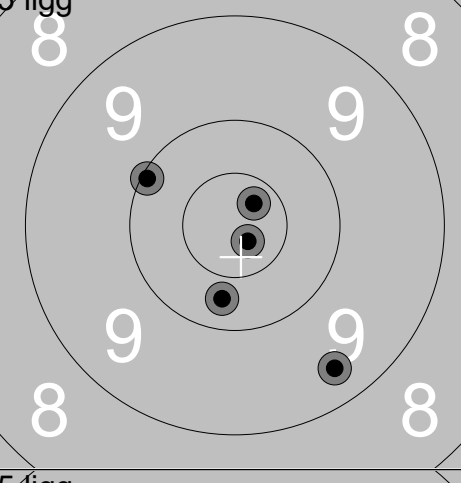
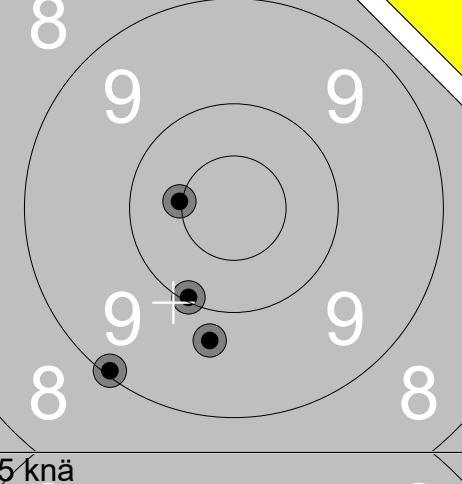
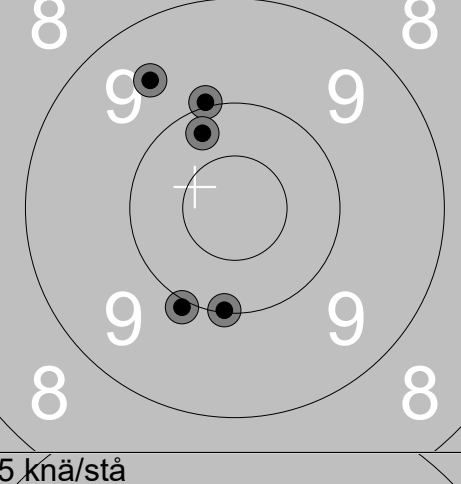
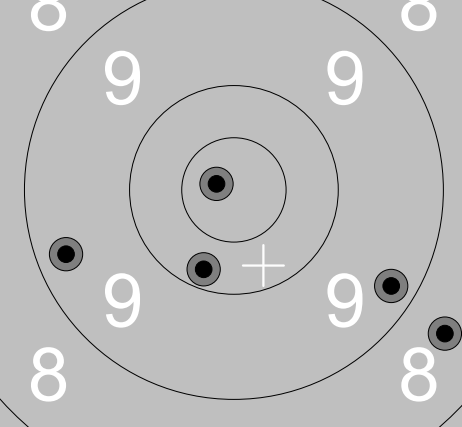
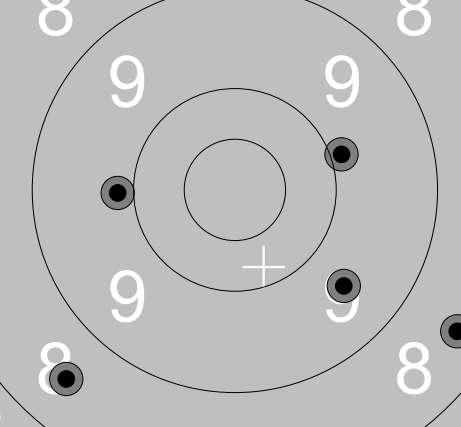
Skjutlag	Tavla	Harry Östling		
1	6			
Pskf	F21 Skf	Knä		
04.07.2020	Tavelträffen gevär ställning	Piteå Skytteförening		
5 prov		1: 9.4 ↘ 2: 9.6 → 3: 9.3 ↘ 4: 10.6x ↗	5 ligg 	1: 9.9 ↑ 2: 10.6x ↗ 3: 10.4 ↗ 4: 9.6 ↓ 5: 9.9 ↓
	Serie 37 (1x) Total 0 (0x)		Serie 47 (1x) Total 47 (1x)	
5 ligg		1: 10.0 ↖ 2: 10.7x ↓ 3: 9.5 ↓ 4: 9.5 ← 5: 10.4x ←	5 ligg 	1: 9.4 ↓ 2: 10.8x ↓ 3: 10.7x ↗ 4: 10.1 ↖ 5: 10.3 ↓
	Serie 48 (2x) Total 95 (3x)		Serie 49 (2x) Total 144 (5x)	
4 prov		1: 10.5x ← 2: 9.7 ↓ 3: 9.1 ↘ 4: 10.1 ↓	5 ligg 	1: 10.0 ↘ 2: 9.6 ↖ 3: 10.0 ↖ 4: 10.2 ↖ 5: 10.0 ↓
	Serie 38 (1x) Total 144 (5x)		Serie 49 (0x) Total 193 (5x)	
5 knä		1: 8.6 ↘ 2: 10.8x ↖ 3: 10.2 ↘ 4: 9.3 ↘ 5: 9.3 ←	5 knä/stå 	1: 9.9 → 2: 8.4 ↓ 3: 9.9 ← 4: 9.6 ↓ 5: 8.5 ↘
	Serie 46 (1x) Total 239 (6x)		Serie 43 (0x) Total 282 (6x)	

Skjutlag	Tavla	Henry Lindström	
1	7		
Pskf	I19/A9 Skf	Knä	
04.07.2020	Tavelträffen gevär ställning	Piteå Skytteförening	
5 prov		1: 10.1 ↗ 2: 9.6 ↓ 3: 10.2 ↓ 4: 8.9 ↗ 5: 9.1 ↗	5 ligg  1: 10.7x ↓ 2: 9.5 ← 3: 10.4x ↓ 4: 9.5 ↗ 5: 10.2 ↓
	Serie 46 (0x) Total 0 (0x)	Serie 48 (2x) Total 48 (2x)	
5 ligg		1: 10.2 ↓ 2: 10.4 ← 3: 10.5x ← 4: 9.9 → 5: 9.5 ↓	5 ligg  1: 10.0 ↗ 2: 10.2 ↗ 3: 8.9 ↓ 4: 10.2 ↓ 5: 10.4 ←
	Serie 48 (1x) Total 96 (3x)	Serie 48 (0x) Total 144 (3x)	
4 prov		1: 8.8 ↗ 2: 9.1 ↗ 3: 9.8 ↓ 4: 10.5x ↓	5 ligg  1: 10.7x ↓ 2: 10.5x ↗ 3: 9.6 ↗ 4: 10.5x ↓ 5: 10.0 ←
	Serie 36 (1x) Total 144 (3x)	Serie 49 (3x) Total 193 (6x)	
5 knä		1: 9.5 → 2: 9.9 ← 3: 9.7 ← 4: 7.2 ↗ 5: 9.9 ←	5 knä/stå  1: 9.9 → 2: 8.4 ↓ 3: 9.7 ↓ 4: 8.7 ↗ 5: 10.8x ↗
	Serie 43 (0x) Total 236 (6x)	Serie 44 (1x) Total 280 (7x)	

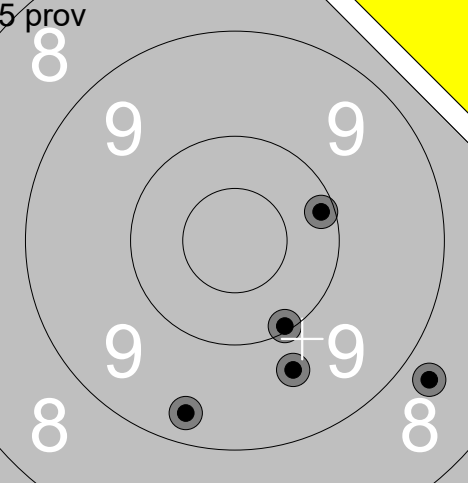
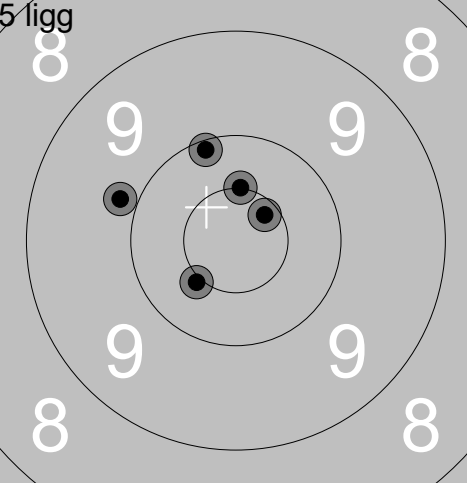
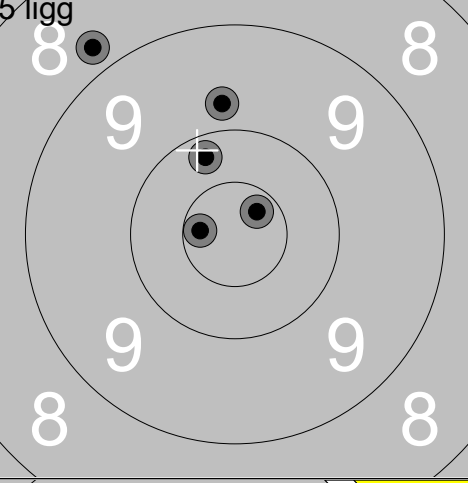
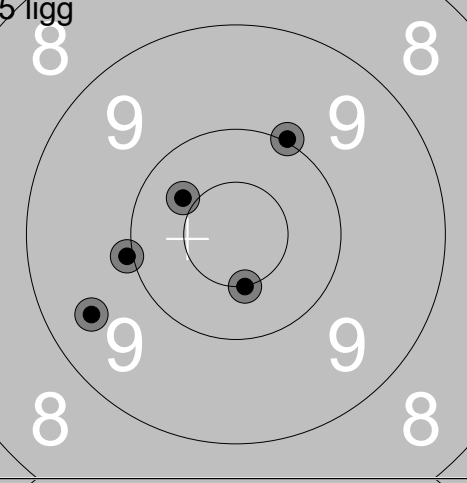
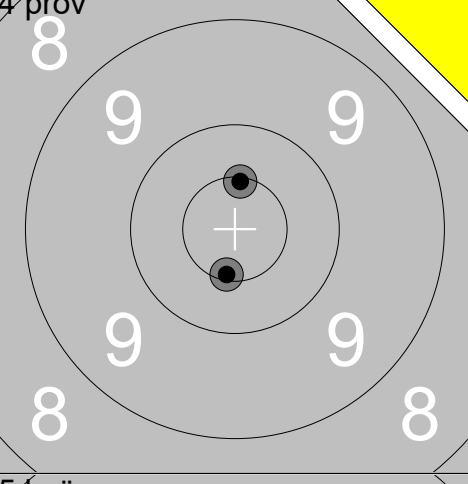
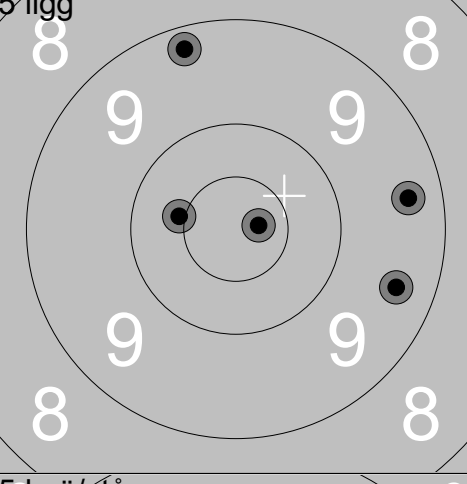
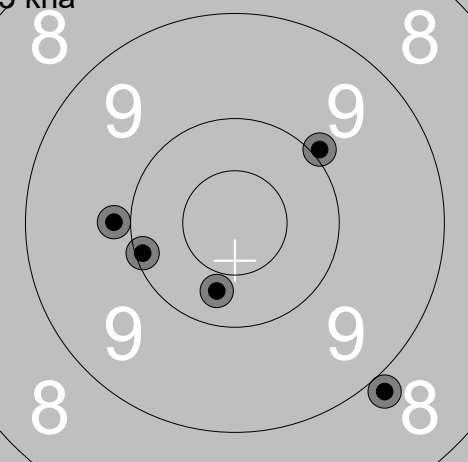
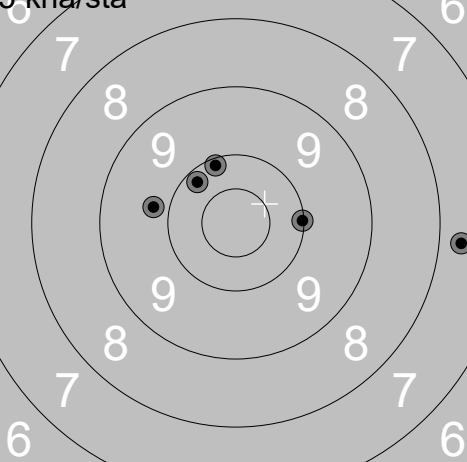
Skjutlag	Tavla	Donald Johansson			
1	8				
Pskf	Ale Skf	Knä			
04.07.2020	Tavelträffen gevär ställning	Piteå Skytteförening			
5 prov		1: 8.7 → 2: 9.3 ↓ 3: 10.1 → 4: 9.7 ↓ 5: 10.1 ↓	5 ligg		1: 10.1 ↗ 2: 10.5x ↑ 3: 9.9 ← 4: 10.4x ↙ 5: 10.6x ↗
	Serie 46 (0x)		Serie 49 (3x)		
	Total 0 (0x)		Total 49 (3x)		
5 ligg		1: 10.6x ← 2: 9.8 ↑ 3: 10.7x ↗ 4: 10.2 ↑ 5: 8.8 ↗	5 ligg		1: 9.5 ↙ 2: 10.4 ↙ 3: 10.0 ← 4: 10.5x ↓ 5: 10.0 ↑
	Serie 47 (2x)		Serie 49 (1x)		
	Total 96 (5x)		Total 145 (6x)		
4 prov		1: 10.5x ↓ 2: 10.5x ↑	5 ligg		1: 10.4x ↙ 2: 10.7x → 3: 9.4 → 4: 9.2 ↑ 5: 9.4 →
	Serie 20 (2x)		Serie 47 (2x)		
	Total 145 (6x)		Total 192 (8x)		
5 knä		1: 9.9 ← 2: 10.3 ↓ 3: 10.0 ↗ 4: 10.1 ← 5: 8.9 ↓	5 knä/stå		1: 10.0 → 2: 7.7 → 3: 9.8 ← 4: 10.2 ↗ 5: 10.1 ↑
	Serie 47 (0x)		Serie 46 (0x)		
	Total 239 (8x)		Total 285 (8x)		

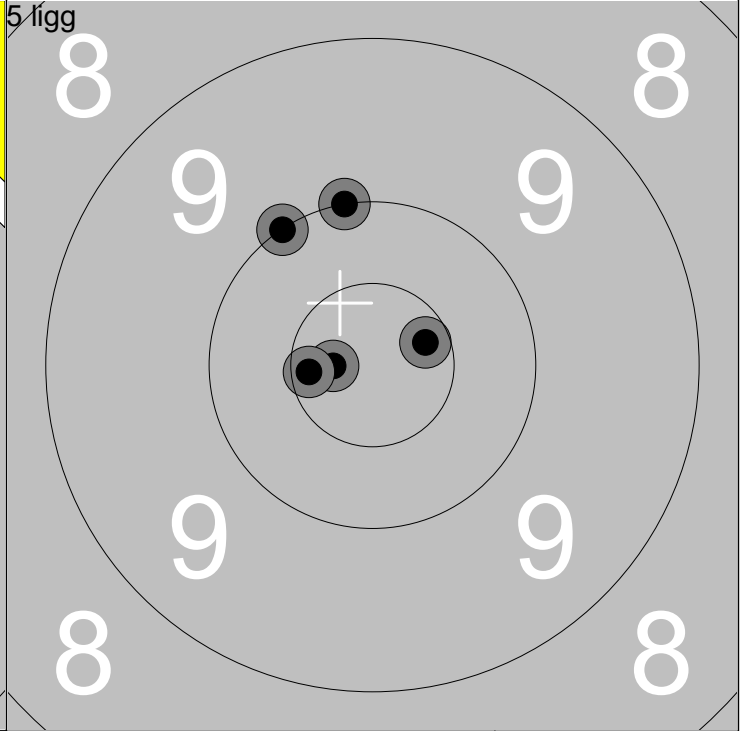
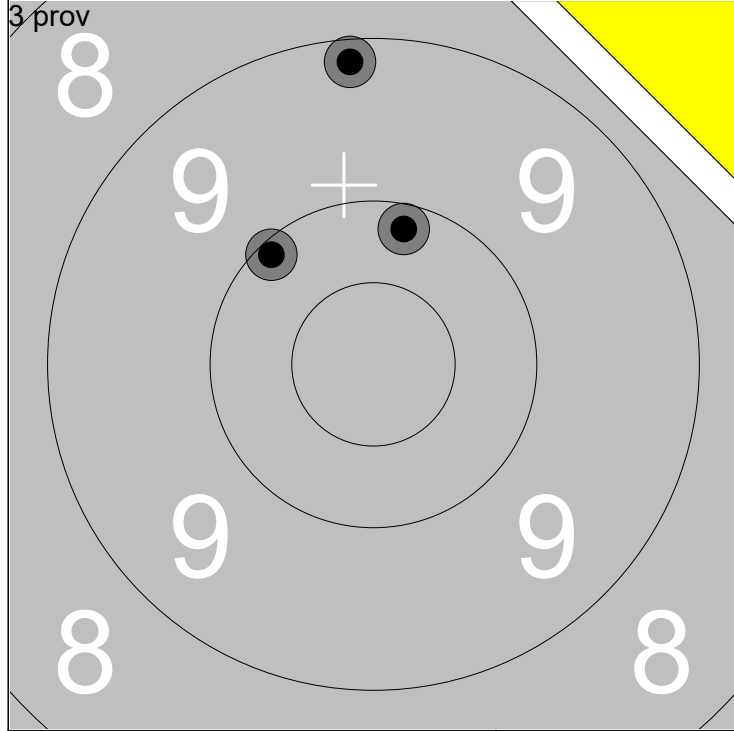

1: 9.2	↑
2: 10.1	↖
3: 10.2	↑

Serie	29 ( 0x)
Total	275 ( 0x)

1: 10.6x	➔
2: 10.7x	←
3: 10.0	↖
4: 10.0	↑
5: 10.6x	←

Serie	50 ( 3x)
Total	325 ( 3x)

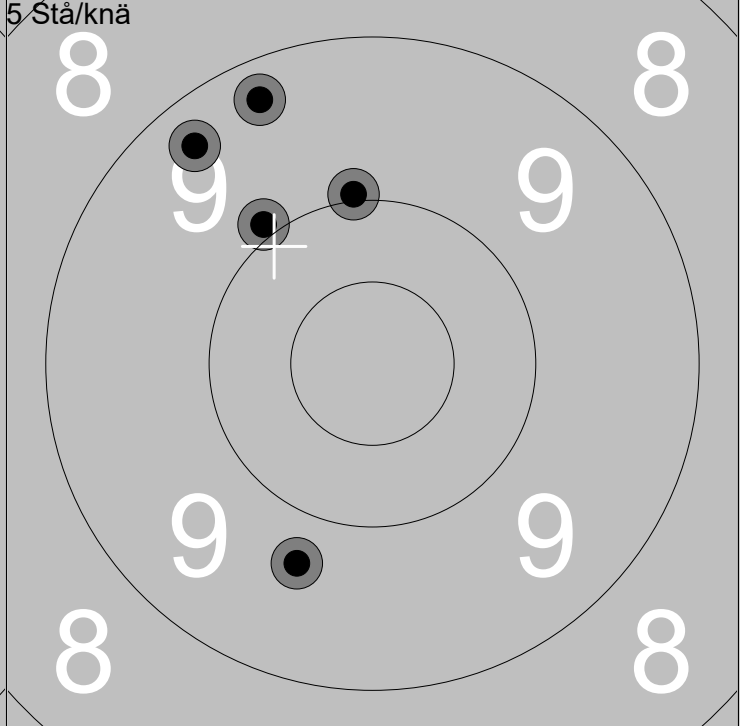
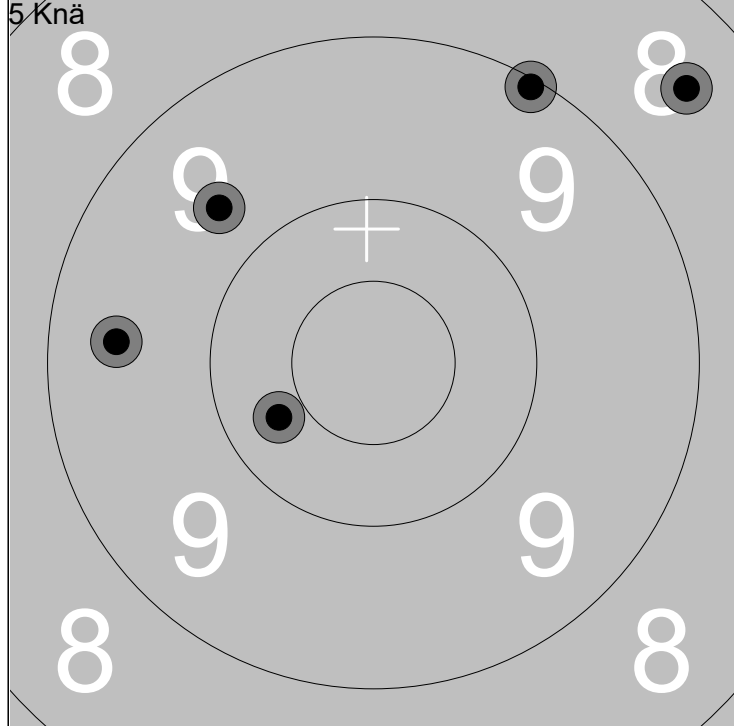

1: 8.5	↗
2: 9.1	↗
3: 9.7	↖
4: 9.5	←
5: 10.3	↙

Serie	45 ( 0x)
Total	370 ( 3x)

1: 10.0	↑
2: 9.3	↖
3: 9.7	↙
4: 9.9	↖
5: 9.3	↖

Serie	46 ( 0x)
Total	416 ( 3x)

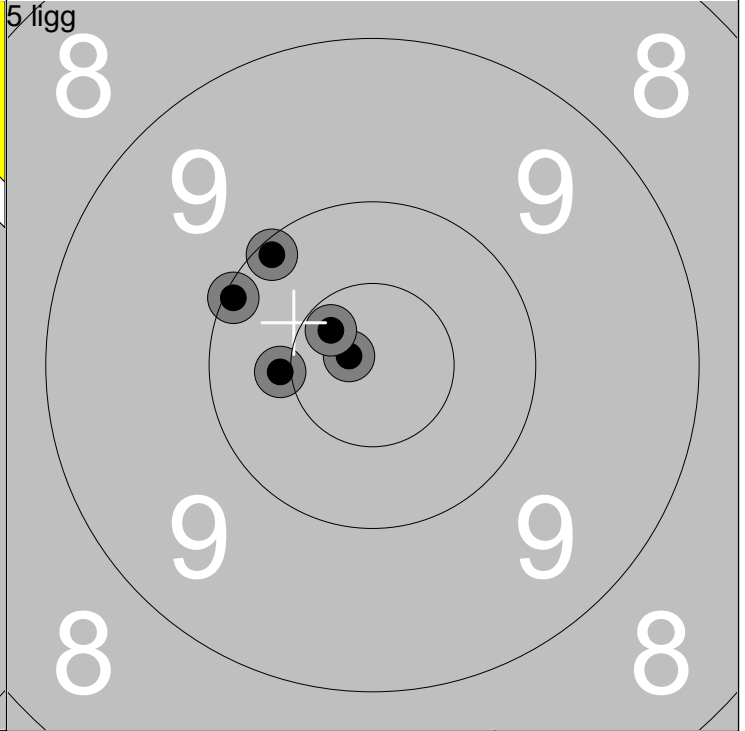
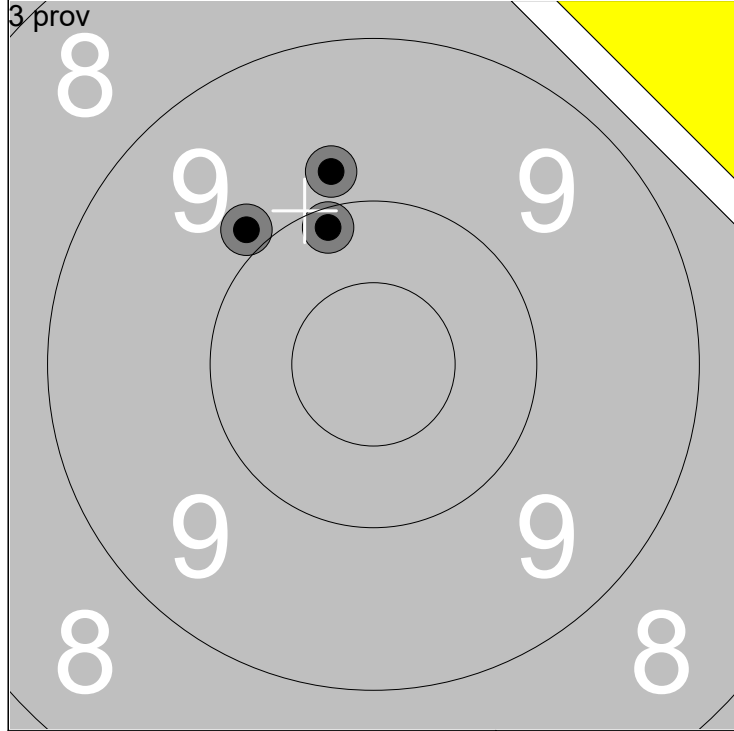

1:	9.8	↑
2:	9.9	↖
3:	10.1	↑

Serie	28 (0x)
Total	277 (0x)

1:	10.1	↖
2:	10.4x	←
3:	10.1	↖
4:	10.8x	↖
5:	10.6x	↖

Serie	50 (3x)
Total	327 (3x)

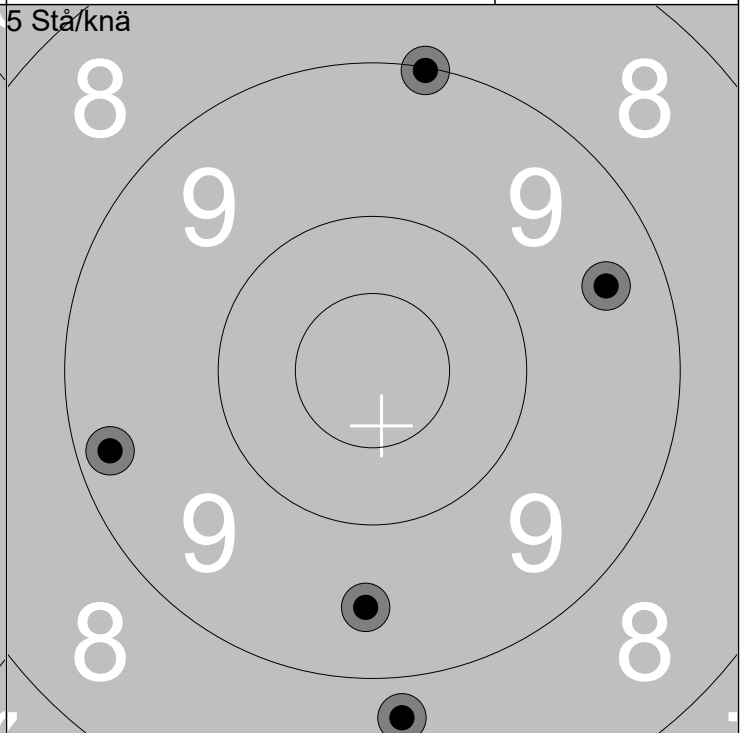
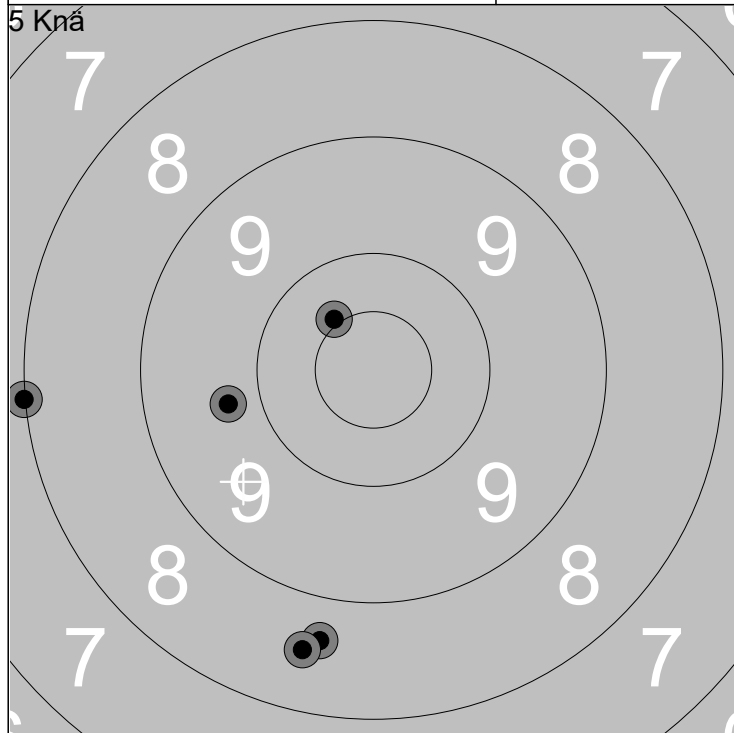

1:	8.7	↓
2:	9.8	←
3:	8.0	←
4:	8.5	↓
5:	10.4x	↖

Serie	43 (1x)
Total	370 (4x)

1:	8.8	↓
2:	9.5	↓
3:	9.4	↗
4:	9.2	←
5:	9.0	↑

Serie	44 (0x)
Total	414 (4x)

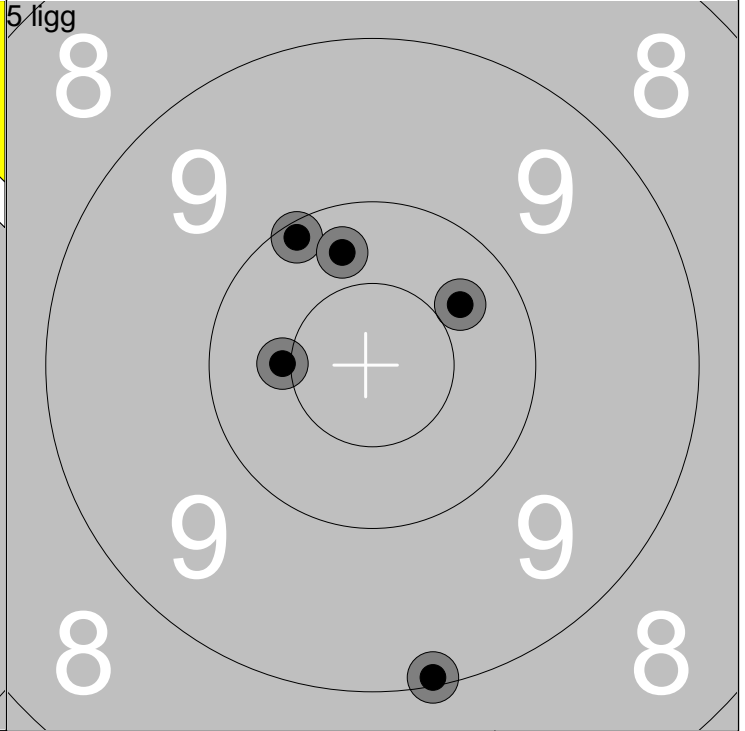
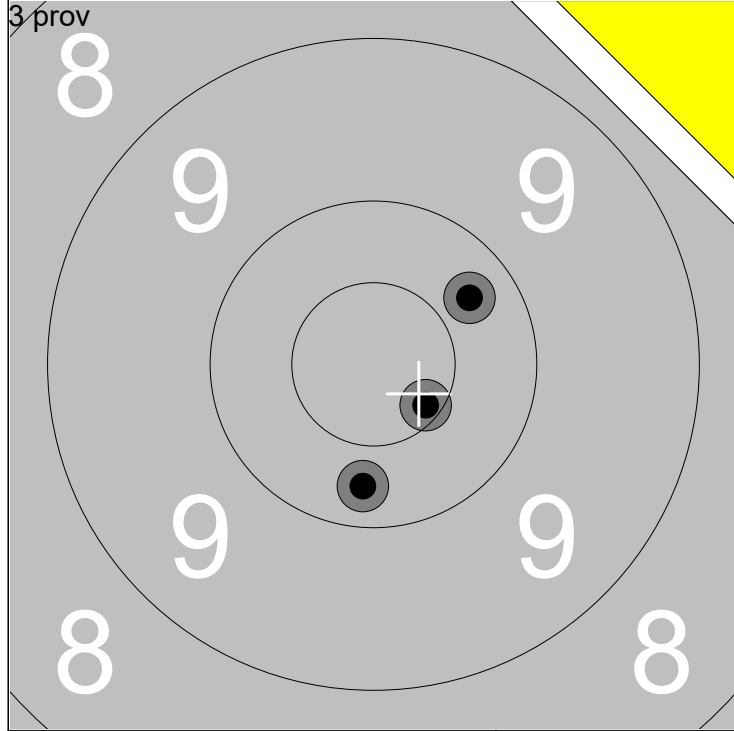

1: 10.6x ↘
2: 10.3 ↓
3: 10.3 ↗

Serie	30 ( 1x)
Total	264 ( 0x)

1: 10.1 ↖
2: 10.3 ↗
3: 9.1 ↓
4: 10.3 ↗
5: 10.4x ←

Serie	49 ( 1x)
Total	313 ( 1x)

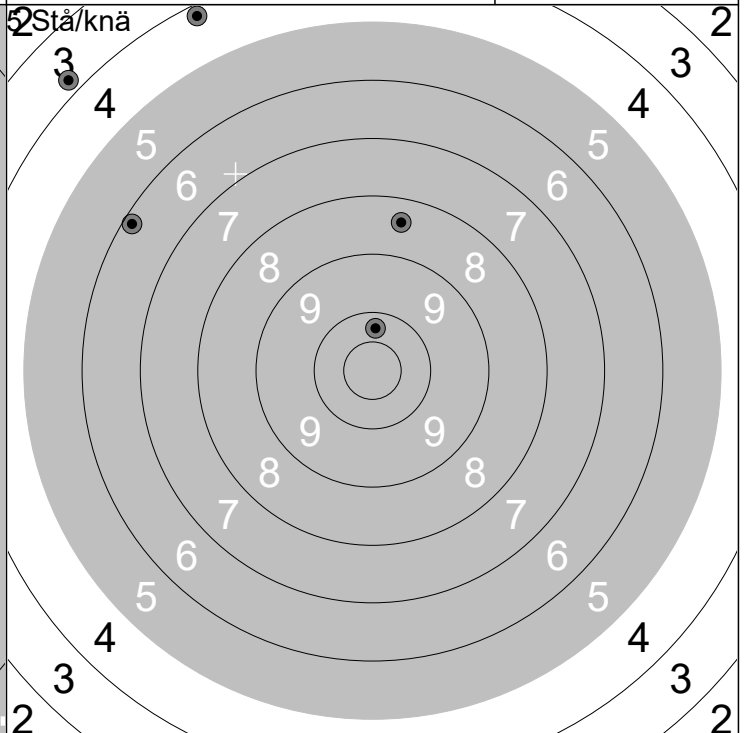
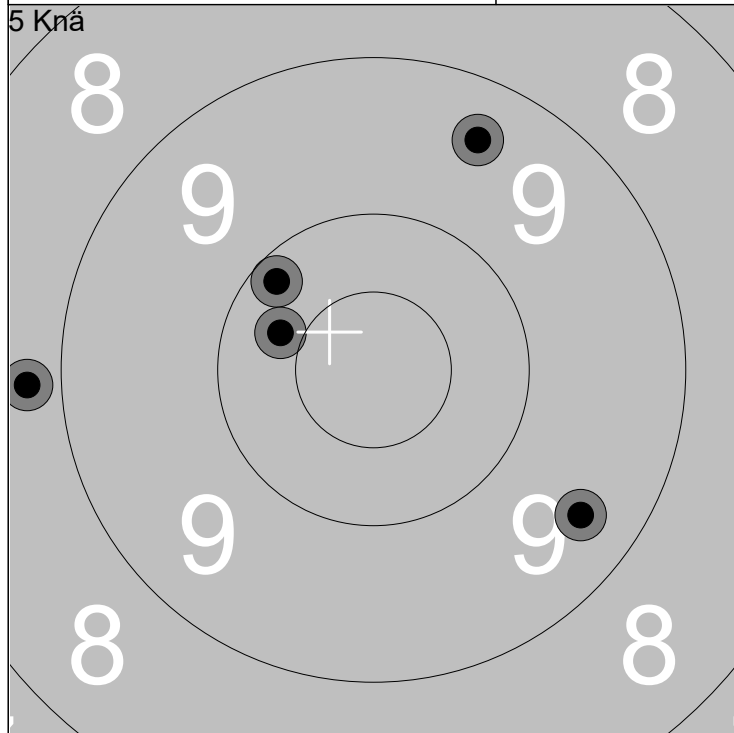

1: 10.2 ↖
2: 10.4 ↖
3: 9.4 ↗
4: 9.4 ↘
5: 8.8 ←

Serie	46 ( 0x)
Total	359 ( 1x)

1: 10.3 ↑
2: 4.2 ↖
3: 8.4 ↑
4: 6.2 ↖
5: 3.8 ↖

Serie	31 ( 0x)
Total	390 ( 1x)

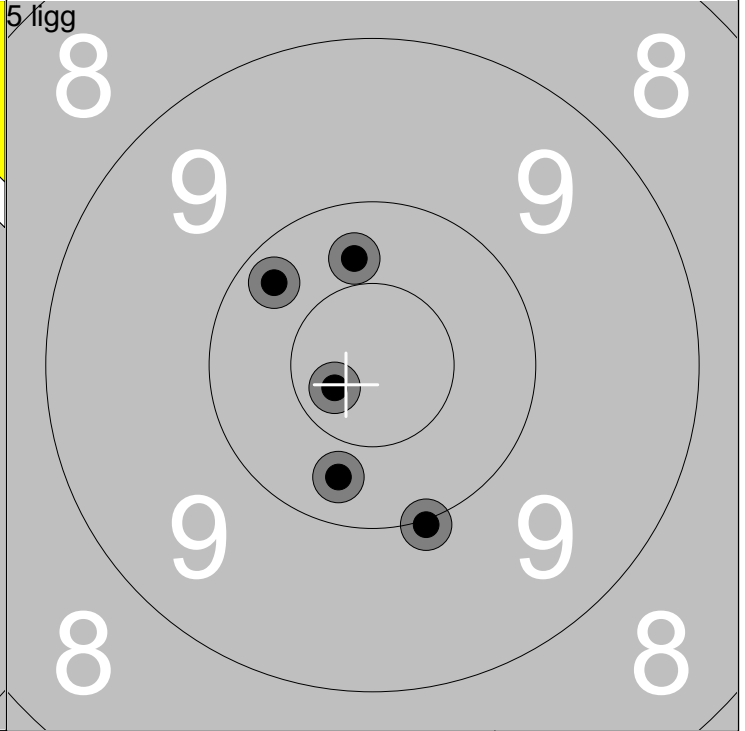
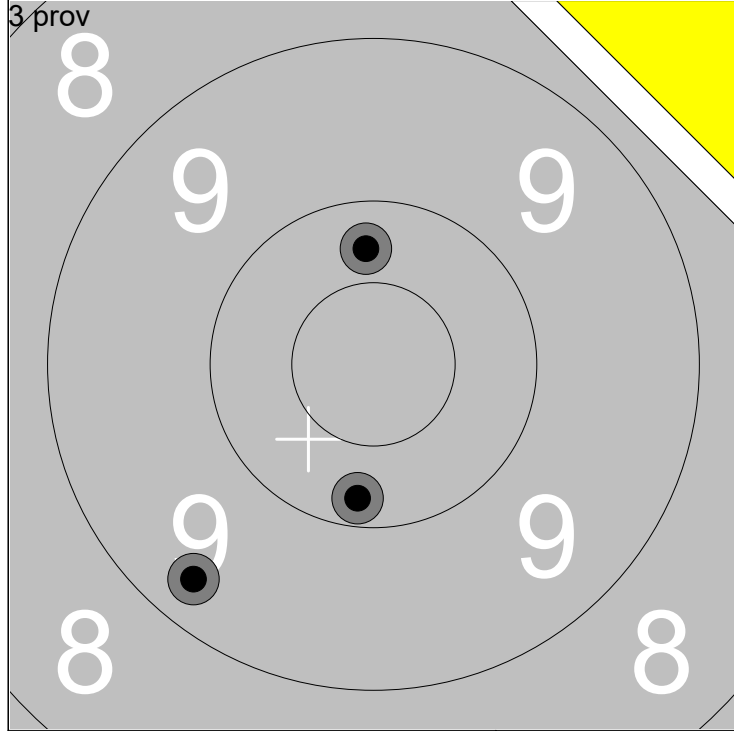

1: 9.3 ↙	Serie	29 ( 0x)
2: 10.3 ↑		
3: 10.2 ↓		
Total		282 ( 0x)

1: 10.7x ↙	Serie	50 ( 1x)
2: 10.2 ↖		
3: 10.3 ↑		
4: 10.0 ↓		
5: 10.3 ↓		
Total		332 ( 1x)

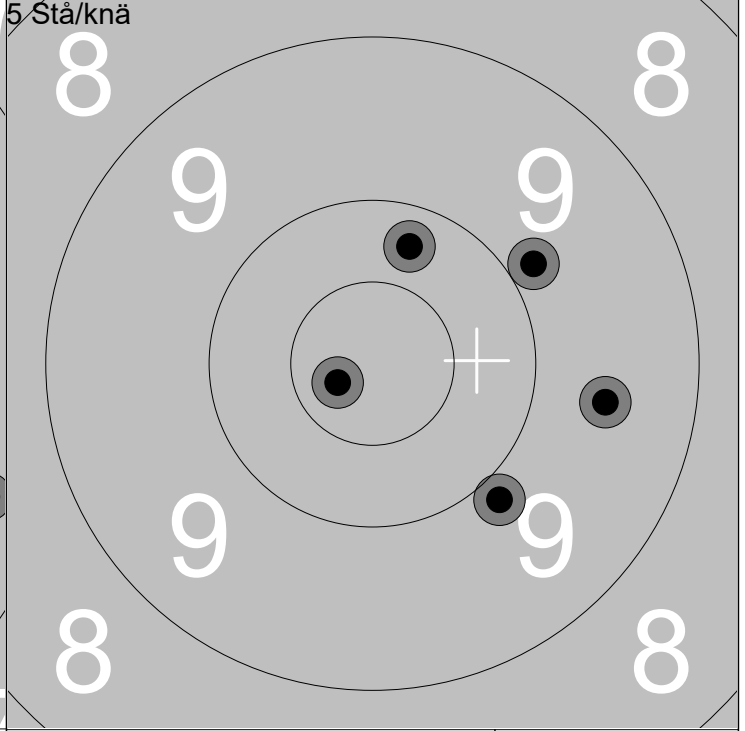
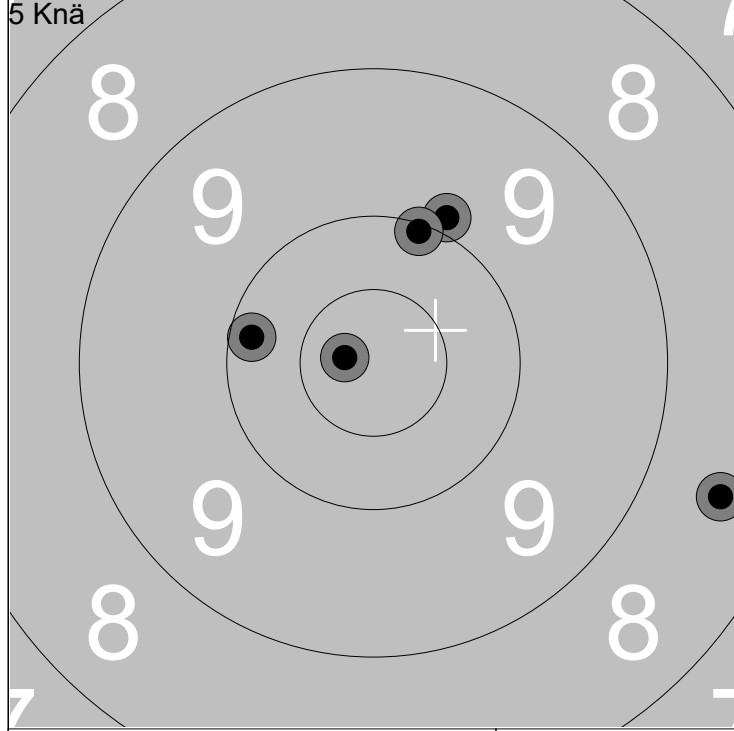

1: 9.9 ↗	Serie	47 ( 1x)
2: 10.8x ↖		
3: 8.5 ➡		
4: 10.2 ↖		
5: 10.1 ↗		
Total		379 ( 2x)

1: 10.3 ↗	Serie	47 ( 1x)
2: 9.6 ➡		
3: 9.9 ↗		
4: 10.7x ↖		
5: 9.9 ↘		
Total		426 ( 3x)



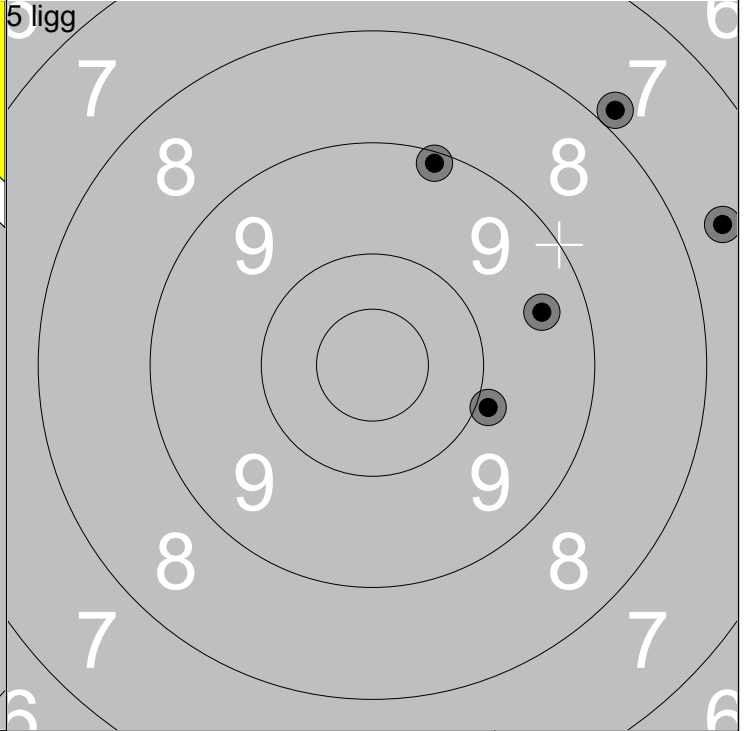
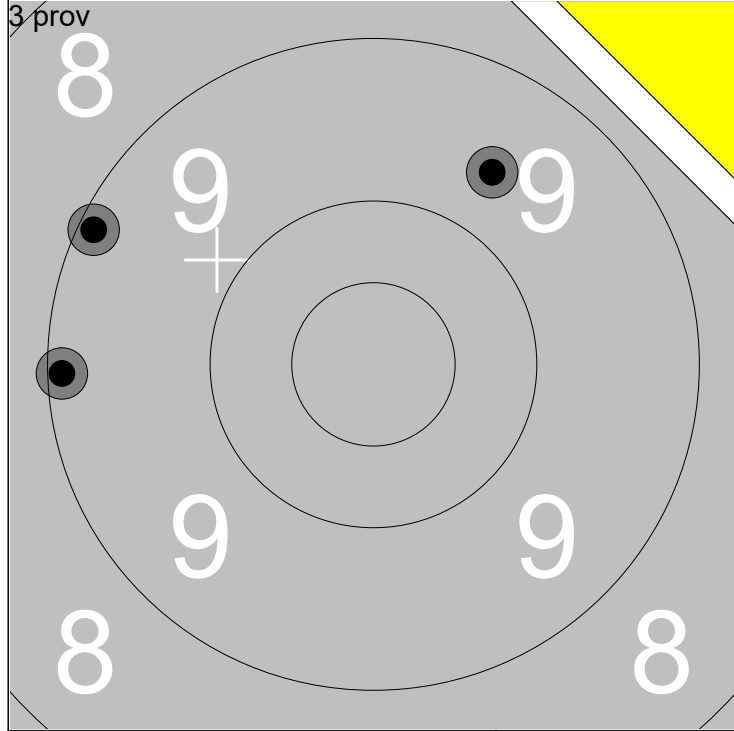

1: 9.1 ←	Serie 27 (0x)
2: 9.1 ↖	
3: 9.6 ↗	
Total 280 (0x)	

1: 9.9 →	Serie 41 (0x)
2: 7.9 ↗	
3: 7.6 →	
4: 9.4 →	
5: 9.1 ↗	
Total 321 (0x)	

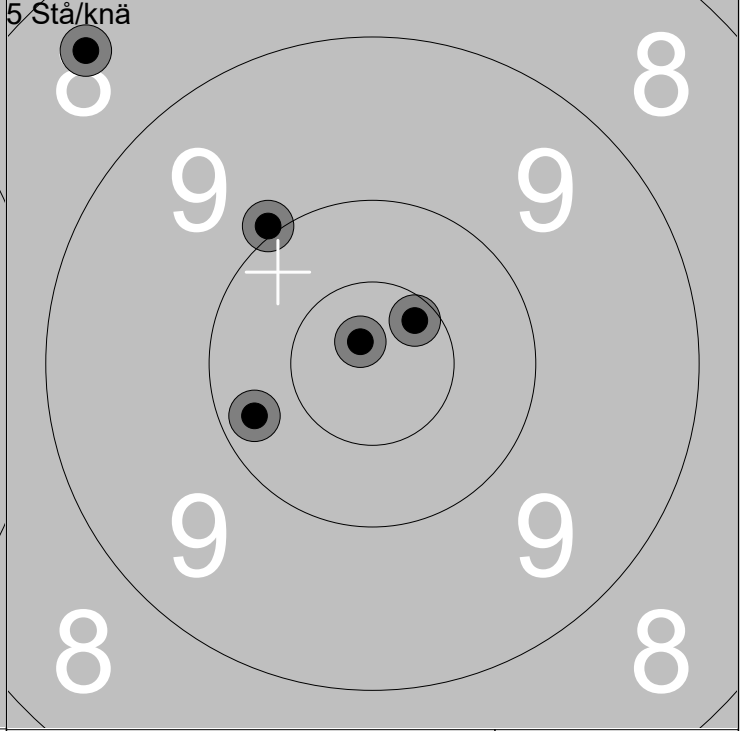
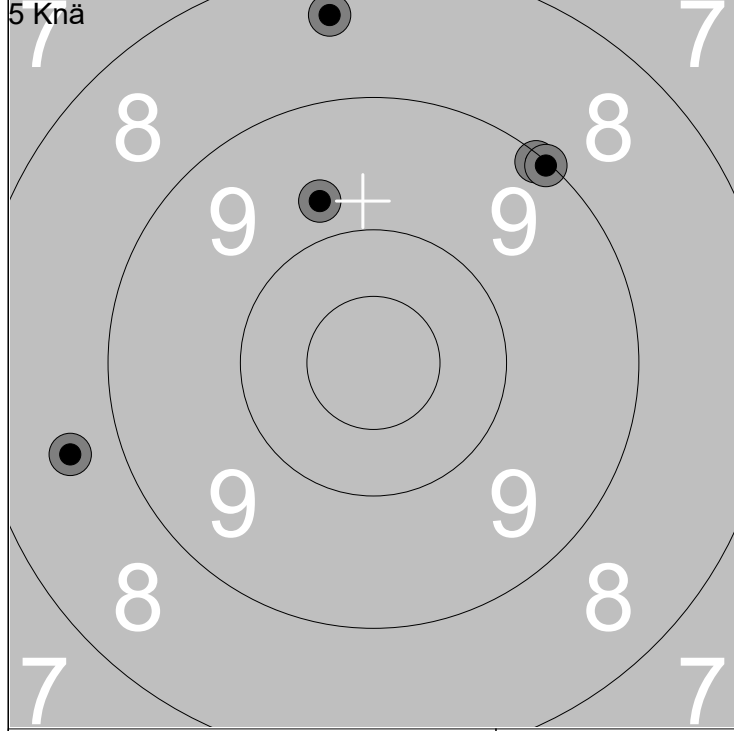

1: 9.7 ↗	Serie 43 (0x)
2: 8.6 ←	
3: 9.1 ↗	
4: 8.4 ↗	
5: 9.1 ↗	
Total 364 (0x)	

1: 10.2 ←	Serie 48 (2x)
2: 8.4 ↖	
3: 10.6x ↗	
4: 10.0 ↖	
5: 10.8x ↖	
Total 412 (2x)	

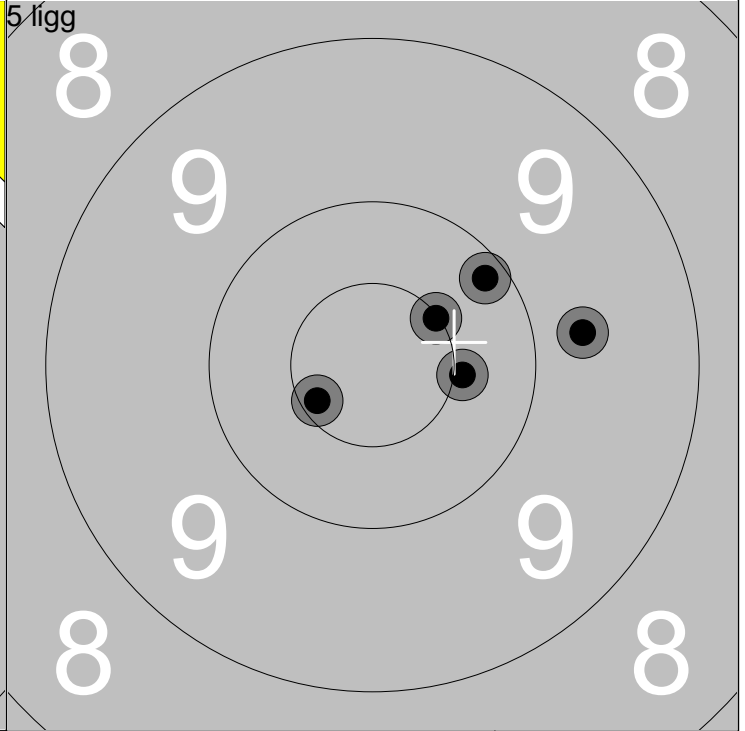
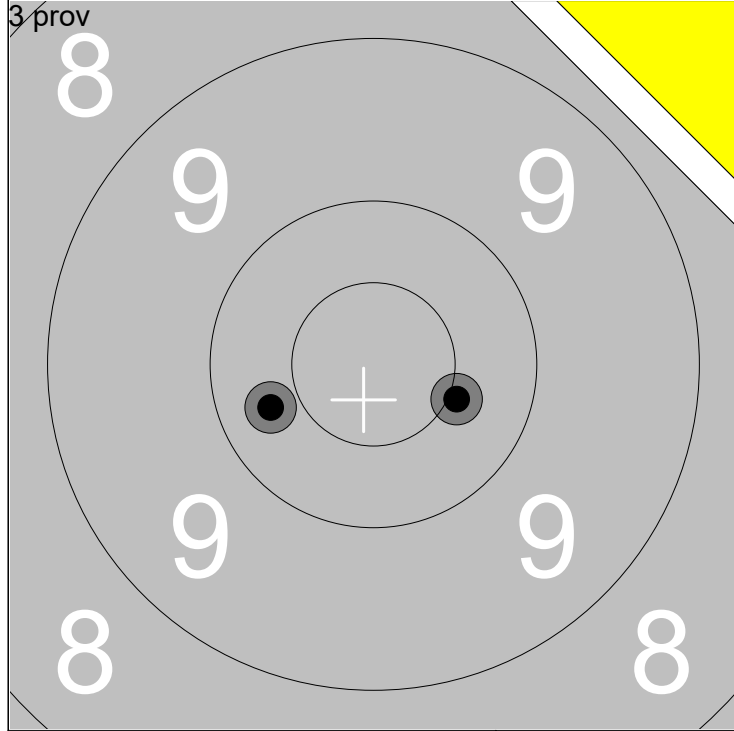

1: 10.3 ←	Serie	20 ( 1x)
2: 10.4x ➤		
Total		285 ( 0x)

1: 9.7 ➔	Serie	49 ( 3x)
2: 10.4x ➔		
3: 10.5x ↗	Total	
4: 10.1 ↗		
5: 10.6x ↙		
Total		334 ( 3x)

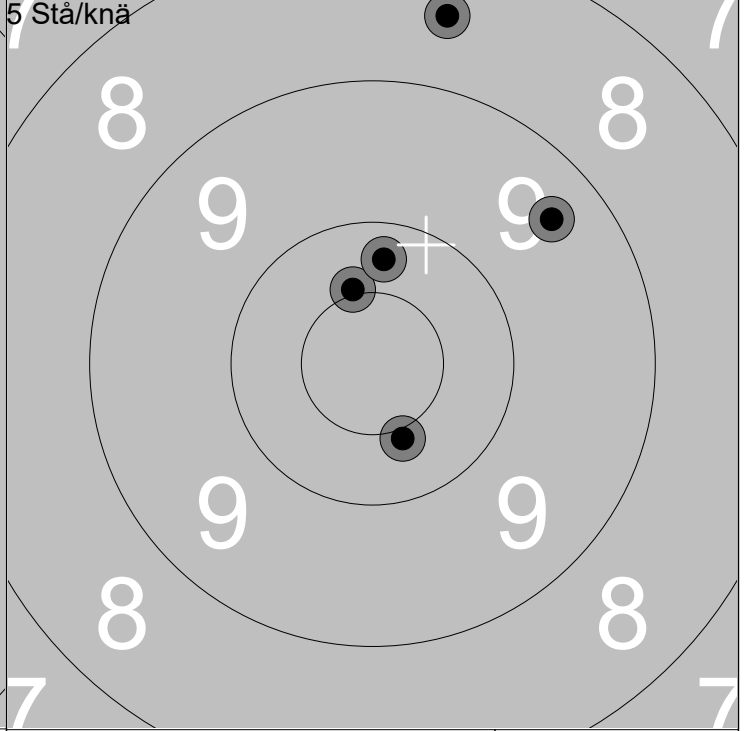
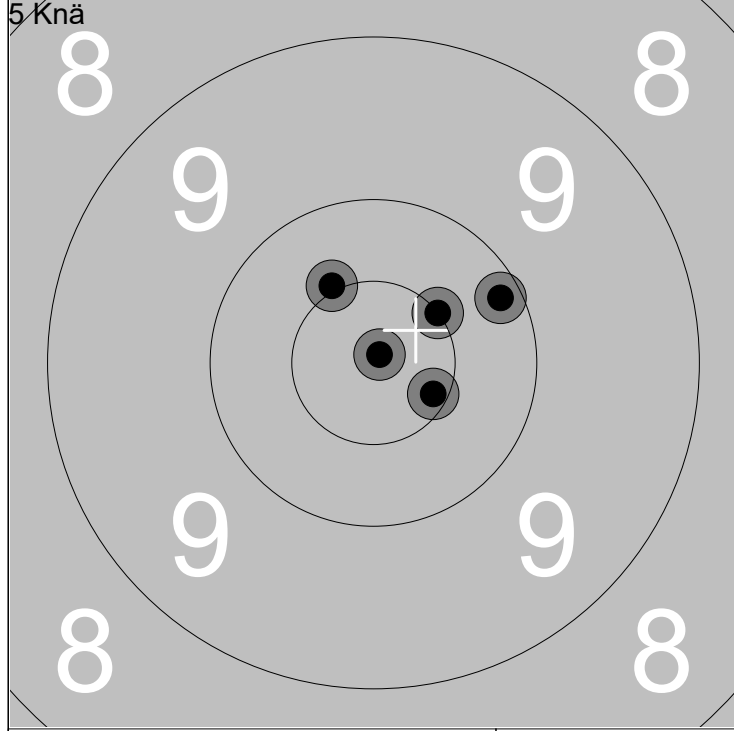

1: 10.5x ↖	Serie	50 ( 4x)
2: 10.9x ↗		
3: 10.6x ➤	Total	
4: 10.5x ↗		
5: 10.1 ↗		
Total		384 ( 7x)

1: 10.4x ↖	Serie	47 ( 2x)
2: 10.3 ↖		
3: 8.5 ↖	Total	
4: 10.4x ↘		
5: 9.4 ↗		
Total		431 ( 9x)